

AM · FM · TELEVISION

BROADCAST NEWS

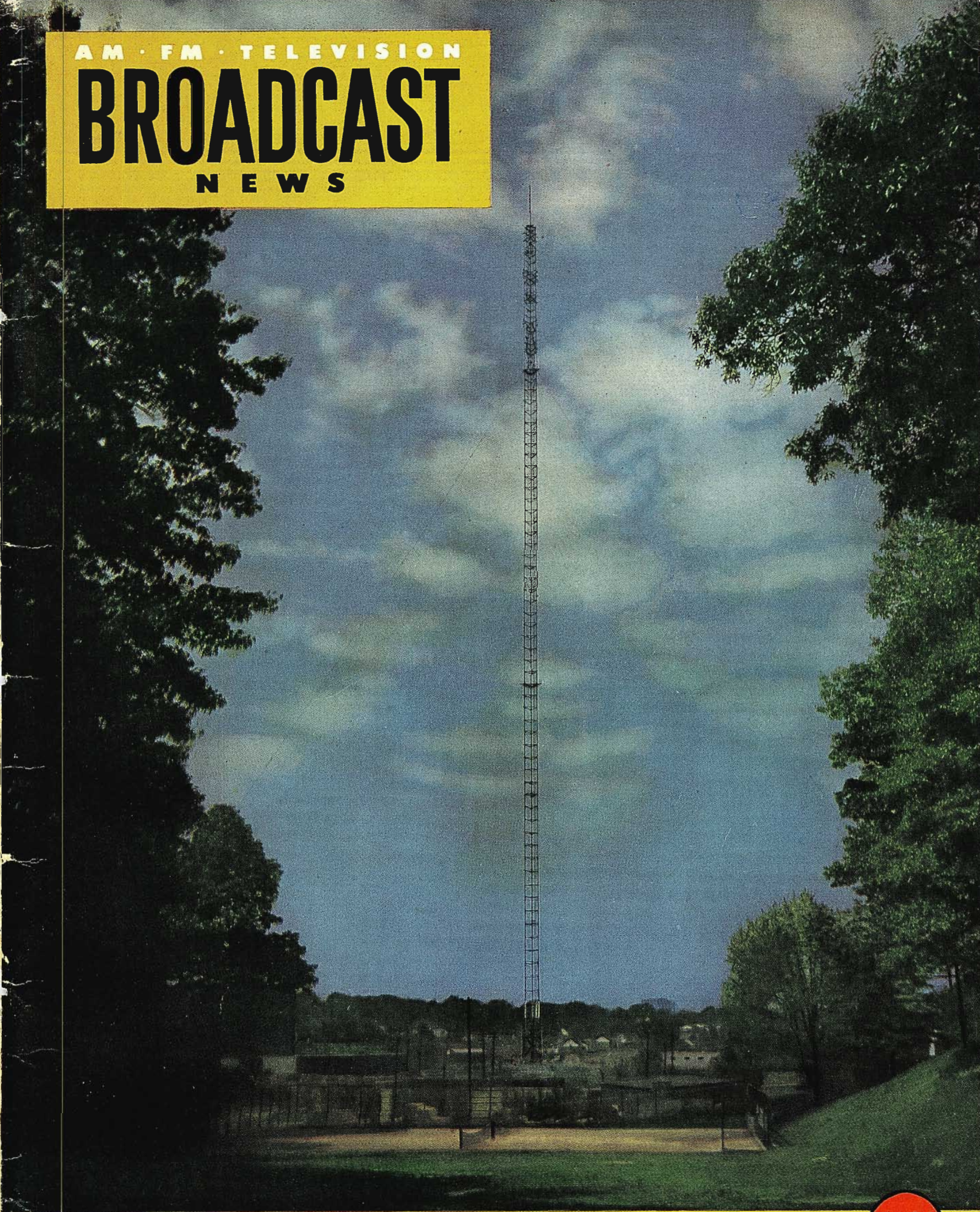

1000 FT. FM-TV ANTENNA See Pg. 8



SEE INSIDE BACK COVER

RCA BROADCAST EQUIPMENT



AM • FM • TELEVISION
BROADCAST
EQUIPMENT

1950 Edition!
OVER 400 PAGES

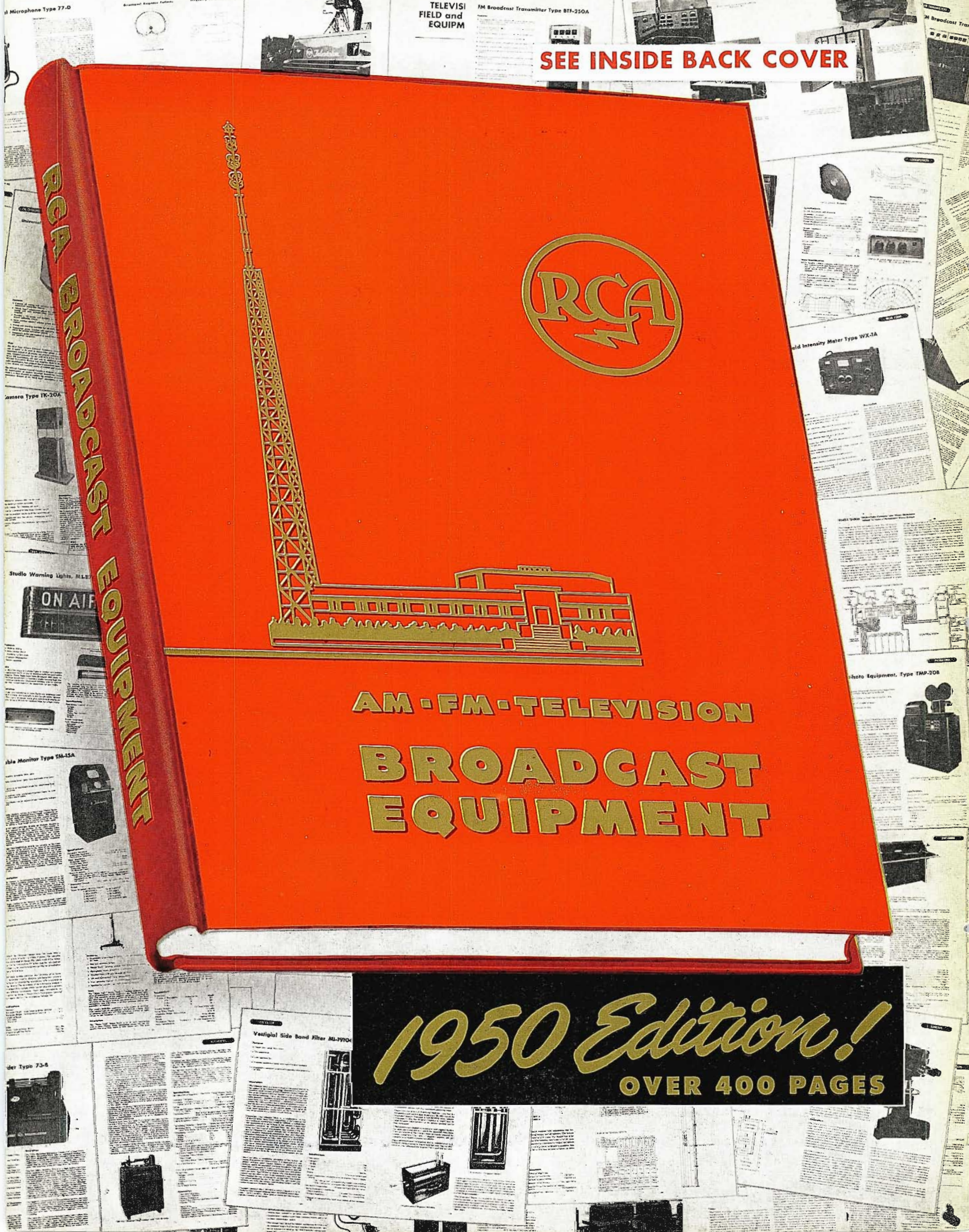

Broadcast News

AM • FM • TELEVISION

...

Published by the

RADIO CORPORATION OF AMERICA

ENGINEERING PRODUCTS DEPARTMENT . . . CAMDEN, NEW JERSEY

NUMBER 59

Subscription Rates

MAY-JUNE, 1950

In continental U. S. A. - \$4.00 for 12 issues
In other countries - . . . \$5.00 for 12 issues

JOHN P. TAYLOR, Editor

JUDY J. ALESI, Ass't Editor

W. O. HADLOCK, M. L. GASKILL, E. B. MAY, Associate Editors

Contents

KB-3A, HIGH-FIDELITY, NOISE CANCELLING MICROPHONE	by L. J. ANDERSON AND L. M. WIGINGTON	4
1057-FOOT FM-TV ANTENNA		8
COMBINING TV TRANSMITTER CONTROL AND PROGRAM SWITCHING	by W. L. LYNDON AND W. T. DOUGLAS, JR.	16
NEW "UNOBTRUSIVE" RIBBON-PRESSURE MICROPHONE	by H. F. OLSON AND JOHN PRESTON	24
NAB ENGINEERING CONFERENCE		32
RCA SHOWS NEW EQUIPMENT AT NAB CONVENTION		36
KRMG, TULSA'S NEW "FIFTY"	by A. F. WOOSTER AND K. W. McCRUM	46
KANSAS CITY'S WDAF-TV		50
DEVELOPMENT OF MULTIPLE-STATION ANTENNA FOR EMPIRE STATE BUILDING NOW UNDERWAY		60
WALL-TYPE HOUSING FOR LC-1A "OLSON" SPEAKER		62
HOW TO SHOCK-MOUNT "70" SERIES TURNTABLE		63
COMPOSITION OF THE VIDEO WAVEFORM AS SEEN ON THE SCOPE	by ROBERT M. CROTINGER	64

Copyright
Radio Corporation of America
RCA Victor Division
Camden, N. J.

PRINTED
IN
U.S.A.

OUR COVER is a view (from about a mile away) of the 1057 foot FM-TV tower originally built for WCON-TV, Atlanta. Subsequent to the merger of WCON-TV and WSB-TV it is expected that it will be used by the latter. Full story begins on Pg. 8. The cover picture is reproduced from an Ansco color film made by James M. Clymer, Jr., WCON staff photographer.

UNITED STATIONS building might well be the new name for the Empire State Building (story on Pg. 60). Similarity applies not only in names, but in the fact that it took some real diplomacy to bring together five stations whose reputations for rivalry and no-holds-barred competition is notorious. When the possibility of putting all New York TV stations on the Empire State Building was first mentioned (several years ago) everyone agreed that it was technically possible, and from all engineering viewpoints very desirable—but that it was politically and competitively a hopeless dream. But now it's within sight of being done. And although many factors entered—the chief impelling reason was the fact that the engineers of all stations recognized the need and worked inch by inch to agreement.

HOW STABLE CAN A STABILIZING AMPLIFIER BE, that's what we're wondering after reading a form letter sent out by a manufacturer (who shall remain nameless here). This manufacturer seems to think his amplifier is more stable than our TA-5C. He lists the TA-5C as "unstable with no input." Brother—it just ain't so. The RCA TA-5C Stabilizing Amplifier is absolutely and completely stable under all conditions—either with or without input. And this stability is achieved without the necessity of incorporating feedback circuits. Apparently this manufacturer used information based on early models of our TA-5B, which indeed was unstable under no input conditions. Later 5B's were okay, and instructions for modifying early 5B's, where desired (in many cases it's not important) have been furnished to stations.

The same letter also stated that the input range of the TA-5C was 3.5 to 5 volts (whereas his, behold, would take inputs up to 8 volts). Actually the TA-5C will also work perfectly well with inputs up to 8 volts—although it was only specified for 3.5 to 5 volt operation, since that covered the RMA approval range.

The moral of this little story is plain—get your information on RCA equipment from the man who knows, your RCA Broadcast Sales Representative.

ERRORS are something no one likes to admit. In the fancy-pants magazines they sugar-coat the corrections by labeling them "Errata." It doesn't help much! For no matter what you call it, it's hard for a correction to catalog up with a mistake.

Our policy is to avoid major errors. To accomplish this every technical article is pre-read by at least five people—and non-technical articles by at least three people. However, technical material is hard to set in type—and difficult to proofread. Also, in copying circuit drawings (particularly if values are shown) it is easy to slip a decimal point. Thus, errors do occur despite our best efforts.

Most errors, fortunately, are minor, and are unimportant to the understanding of the article. These we ignore. But there are some errors which because of possible consequences we would like to correct. In the future the final paragraph of this column will be devoted to that purpose. To begin with we would like to note an error in the article on "How To Adjust Frequency Response In Video Amplifiers For TV" (BROADCAST NEWS, No. 58, Pg. 54). In Figure 12, at the top of Pg. 58, the two capacitors should be 1000 uufd, not ufd.

We have also been asked to call attention to errors in the article "How To Check Sync Signals By The 'Pulse Cross' Method." (BROADCAST NEWS, No. 57, Pg. 45). The diagram (Figure 1) accompanying this article contains several errors which probably will not be obvious to the unsuspecting reader. We will send a corrected copy of this diagram to all who drop us a card.

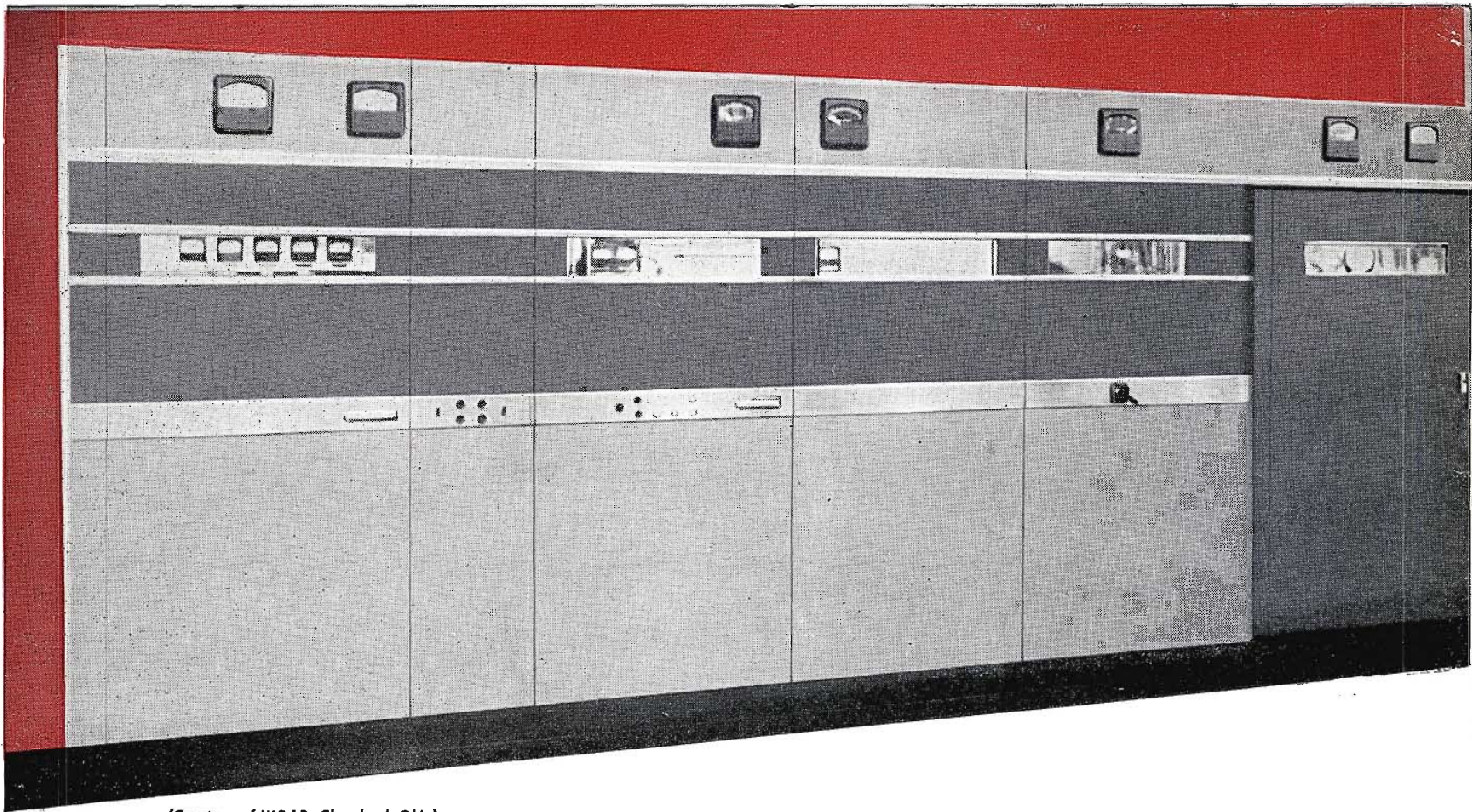

(Courtesy of WGAR, Cleveland, Ohio)

Replace your old AM transmitter *with RCA's new 50 kw...*



The revolutionary, new power triode **RCA-5671**. This tube takes about one-third the filament power of conventional triodes used in the older transmitters. It reduces hum modulation below FCC requirements—*even without r-f feedback*.

The two 5671's in the r-f power amplifier and the two in the class B modulator of this 50-kw transmitter save up to \$1200 yearly in filament power alone.

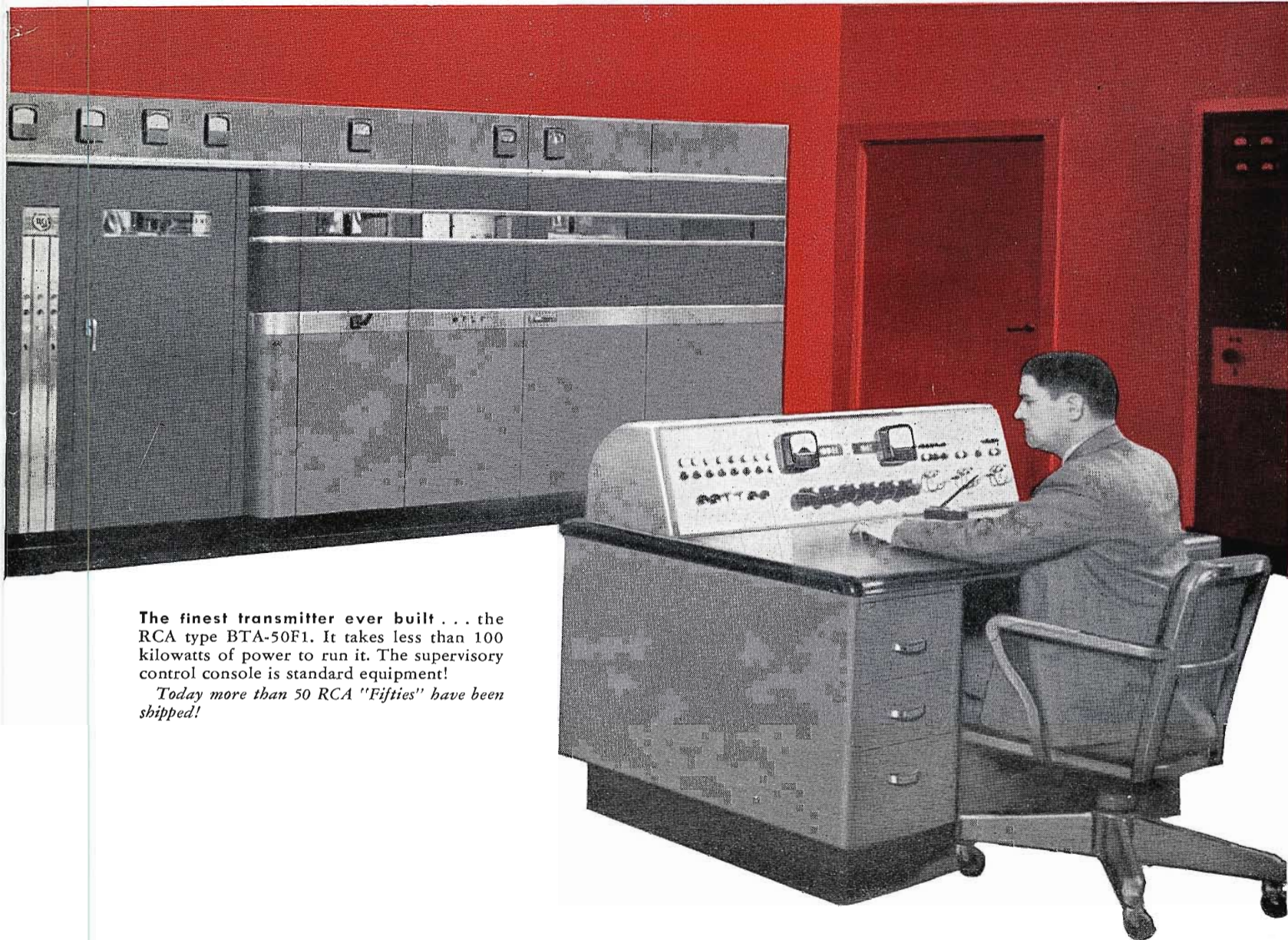

The finest transmitter ever built . . . the RCA type BTA-50F1. It takes less than 100 kilowatts of power to run it. The supervisory control console is standard equipment!

Today more than 50 RCA "Fifties" have been shipped!

and write off its cost in power savings alone!

It's a fact — as one high-power broadcaster recently discovered to his complete satisfaction. Now, he has replaced his old transmitter with an RCA "fifty"—and it's paying its way.

HERE'S WHY.

Using revolutionary new RCA-5671 power triodes that take about one-third the filament power of conventional types, this RCA "fifty" saves up to \$1.75 an hour in power savings over former transmitters—\$12,000 a year, based on daily operation at 19 hours a day!

Many other new design features, too, that add to this \$12,000 savings.

For example, only 29 tubes and 11 different tube types—less than half the number used in many present 50 kw's. True walk-in accessibility that assures faster maintenance — and lowers maintenance costs. Ultra-conservative operation of tubes and components—with less chance for outages.

Here is a 50-kw AM transmitter that does away entirely with oil circuit breakers—assures faster circuit protection. Because the BTA-50F1 operates from a 460-volt supply. Control and protection circuits are

the most complete of any transmitter designed to date. And its true unified front (an integral part separate from compartment enclosures) facilitates flush-mounting — gives your transmitter room a new, handsome appearance.

Write for the new 28-page brochure about the BTA-50F1. It gives you complete details—including circuits, specifications, floor plans, and full-page pictures showing the remarkable accessibility of this great transmitter.

Dept. 19HC, RCA Engineering Products, Camden, New Jersey.



BROADCAST EQUIPMENT
RADIO CORPORATION of AMERICA
ENGINEERING PRODUCTS DEPARTMENT, CAMDEN, N.J.

In Canada: RCA VICTOR Company Limited, Montreal

KB-3A, HIGH-FIDELITY, NOISE-CANCELLING MICROPHONE

By

L. J. ANDERSON and L. M. WIGINGTON

Audio Engineering Section

The need has long existed for a high-fidelity, close-talking microphone which will provide better discrimination against background noise than do present microphones.

In broadcasting, there is need for a close-talking microphone which can be used successfully in connection with audience participation programs which use public address systems. It is extremely difficult to maintain a satisfactory level from the P.A. system without encountering acoustic feedback when conventional microphones are used. A close-talking type of micro-

phone is also needed for broadcasting or announcing sports events where information is to be relayed to the sportcaster by assistants without interference with the running comment. A microphone having these same features is also needed for man-on-the-street programs where undesired side comments from bystanders must be eliminated. Equally important is the need in the P.A. field where systems must be operated at high values of acoustic gain without feedback.

To fill these needs, a microphone must have the following characteristics: it should

discriminate against a distant sound source or random noise to as great a degree as possible; the response-frequency characteristic should be flat over the frequency range for speech when the sound source is close to the microphone; the output level should be relatively high in order to assure a good ratio of signal to electrical noise. The microphone should be insensitive to breath puffs resulting from closeness to the talker's mouth; the distortion must be low for relatively high sound pressures; and the microphone should be small in size and light in weight so that it may be easily handled.

Talking close to a pressure microphone or talking loudly will help to some extent in realizing the desired objective; however, a gradient microphone is especially effective because it discriminates against a distant source in favor of a close source over a good part of the audio-frequency range. In addition, the gradient microphone discriminates against random sound because of its bi-directional characteristics.

Many close-talking gradient microphones have been made, although most of them have been designed for services where the fidelity requirements were low. An example of this class is the noise-cancelling carbon microphone built during the war and used extensively in military service. Limitations due to noise, restricted frequency range, and distortion are the principal factors which preclude the use of such microphones in systems where fidelity is important.

The well known velocity ribbon microphone is one of the finest and simplest first-order gradient microphones for high fidelity. The use of this type of microphone for close talking has never been considered desirable or feasible because of the excessive low-frequency response obtained under such conditions and because of its sensitivity to excitation by breath puffs.



FIG. 1 (at left). The KB-3A Microphone is a version of the popular KB-2C Bantam Velocity Mike, modified for close-talking applications.

Recent work done in an attempt to improve the windscreening of small velocity microphones has led to the development of the KB-3A, an excellent microphone in which close talking and discrimination against noise are accomplished with a ribbon element as the moving system. The theory of operation is explained in a simplified form in the following discussion.

Theory of Operation

If in Fig. 2 the values of r_{A3} and r_{A4} are made equal to zero, the diagram represents the equivalent electrical circuit of the acoustical, mechanical and electrical elements of a simple velocity microphone.¹

Fig. 3 shows the impedance of the various circuit elements as a function of frequency, and in addition, shows the driving force per unit of free field pressure $\Delta p/p$ which is equivalent to $(p_1 - p_2)/p$ in Fig. 2. The curve $\Delta p/p$ is the driving force obtained when the velocity microphone is driven by a plane progressive sound wave or from a distant source.

The output voltage from the microphone will be

$$e = Blx$$

where $B =$ flux density

$l =$ length of ribbon

$x =$ velocity of the ribbon

and
$$x = \frac{\Delta p}{A_R Z_{AT}} = \frac{\Delta p}{(X_{AA} + X_{AR}) A_R}$$

where Δp is the total driving force for a free-field sound pressure p

$A_R =$ area of the ribbon

$Z_{AT} =$ acoustical impedance of the vibrating system

$X_{AA} =$ acoustical reactance of the air load on the ribbon

$X_{AR} =$ acoustical reactance of the ribbon mass.

The above relationship holds over a large part of the frequency range and as long as Δp is rising with increasing frequency at the same rate as X_{AA} and X_{AR} , the output voltage will remain constant.

If the microphone is placed close to a small sound source, the value of $\frac{\Delta p}{p}$ will

be modified by a factor which will depend on the frequency and the distance

¹ H. F. Olson, "Elements of Acoustical Engineering," Chapter VIII, pages 252-253.

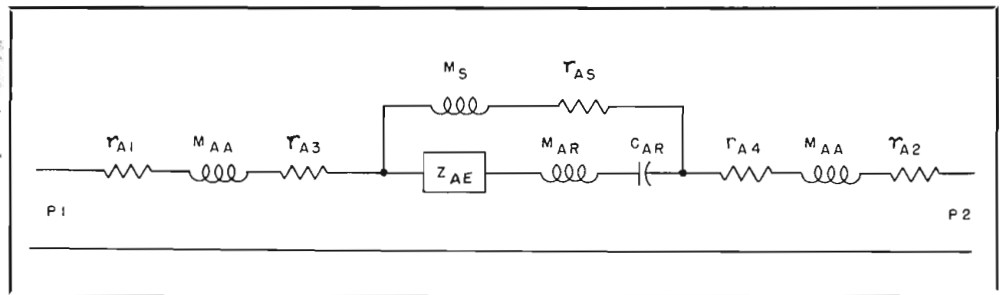

Fig. 2 (above). Equivalent acoustical network of a velocity microphone.

NETWORK SYMBOLS

- $r_{A1}, r_{A2} =$ acoustical resistance of the air load on the front and back of the ribbon.
- $M_{AA} =$ inertances due to the air load on the ribbon.
- $M_{AR} =$ inertance of the ribbon.
- $C_{AR} =$ acoustical capacitance of the ribbon.
- $Z_{AE} =$ acoustical impedance due to the electrical system.
- $M_S =$ inertance due to the slit between the ribbon and pole piece.
- $r_{AS} =$ acoustical resistance due to the slit between the ribbon and pole piece.
- $r_{A3}, r_{A4} =$ acoustic resistance added between microphone screen.
- $P_1, P_2 =$ sound pressure at the front and back of the ribbon.

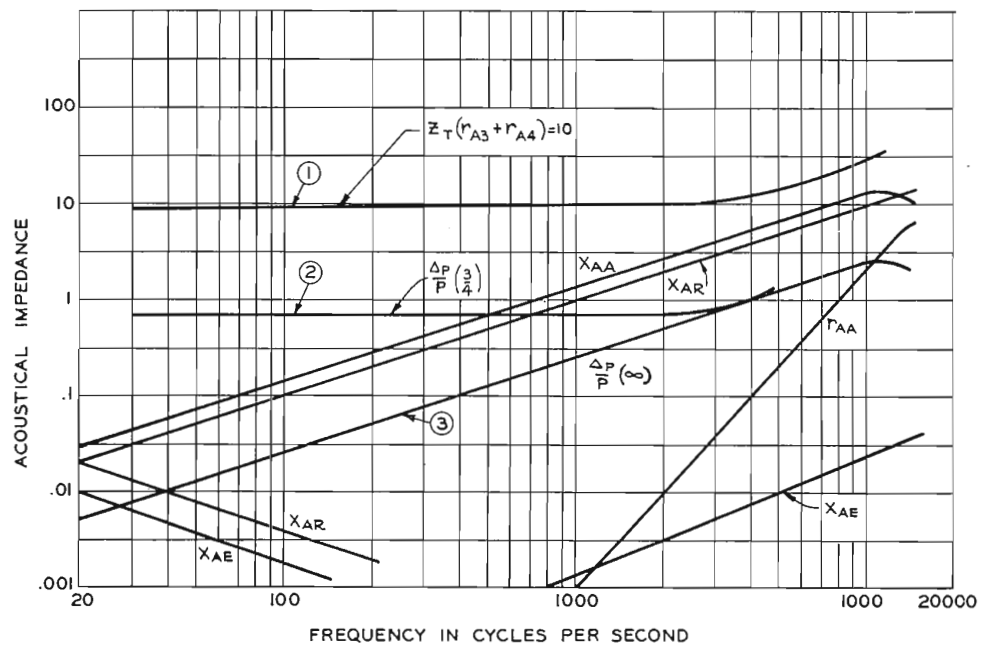

FIG. 3 (above). Acoustical impedance characteristics of a velocity microphone.

to the source. The relationship is shown below.²

$$\frac{\Delta p}{p}(r) = \frac{\Delta p}{p}(\infty) \sqrt{1 + (c/2\pi fr)^2}$$

where $c =$ velocity of sound

$f =$ frequency of source

$r =$ distance to the origin of the spherical wave.

² L. L. Beranek, "Acoustic Measurement," Chapter V, page 230.

The curve $(\Delta p/p) (3/4)$ in Fig. 3 shows this effect on the value of $\Delta p/p$ when the source is at a distance of $3/4$ inch from the microphone. From the trend of this curve, it is obvious that the response of the microphone is no longer a constant with respect to frequency at this distance from the source, but will rise with decreasing frequency starting at about 3000 cps. The rise expressed in db is shown in Fig. 5. This is simply an accentuation of

the familiar "boomy" effect which results when a velocity microphone is used at short distances from the sound source.

When the microphone is to be used only for close talking, this effect can be put to a useful purpose. It will be further observed from Fig. 3 that for frequencies below 1500 cps that $(\Delta p/p) (3/4)$ is very nearly a constant with respect to frequency. In order to make the microphone output voltage a constant with respect to

frequency for this condition, it is therefore necessary that the mechanical impedance of the moving system be independent of frequency over this range. This is readily accomplished by the insertion of suitable values of r_{A3} and r_{A4} in the circuit.

The effect on Z_{AT} is shown at (1) in Fig. 3 when r_{A3} and r_{A4} is equal to 10 acoustic ohms. Again it will be noted that the value of $(\Delta p/p) (3/4)$ and $Z_{AT} (1)$ are parallel functions and as a result the

output will be independent of frequency as long as the microphone is $3/4$ inch from the source. The sensitivity to a plane wave will, however, fall with decreasing frequency, the amount being proportional to the ratio of

$$(\Delta p/p) (\infty) \text{ to } (\Delta p/p) (3/4).$$

In actual practice, the necessary resistances r_{A3} and r_{A4} are added to the acoustic system by placing layers of cotton or fiber glass between the inner and outer screens of the microphone unit. The response-frequency characteristic of the microphone for a small source $3/4$ inch distant is shown at (1) in Fig. 6, and is as predicted essentially flat over the audio range.

Performance Characteristics

The measured response of the microphone to sound originating at a distance from the microphone is shown at (2) in Fig. 6. From this it can be seen that the microphone discriminates against a distant source in favor of a close source by values ranging from 6 db at 1000 cps to 30 db at 100 cps for the equal sound pressures at the microphone element. In addition, because of the directional pattern shown in Fig. 7, the discrimination against random noise is better than the above values by an additional 5 db. The net result is shown by the curve at (3) in Fig. 6.

Fortunately, the acoustic resistance added to secure the desired response results in a microphone which has less sensitivity to wind and breath puffs than is obtained with many diaphragm-type pressure microphones. Further, the damping material serves as an excellent screen to keep foreign matter out of the moving system.

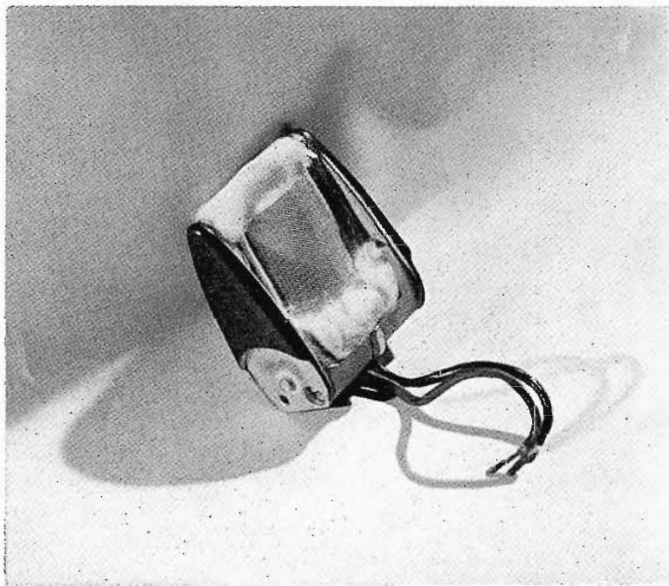

FIG. 4 (at left). View of the KB-3A Microphone with outer screen and part of the acoustical resistance (Fiberglass) removed to illustrate the inner (magnetic) screen. This screen prevents the entry of magnetic dirt particles into the microphone air gap.

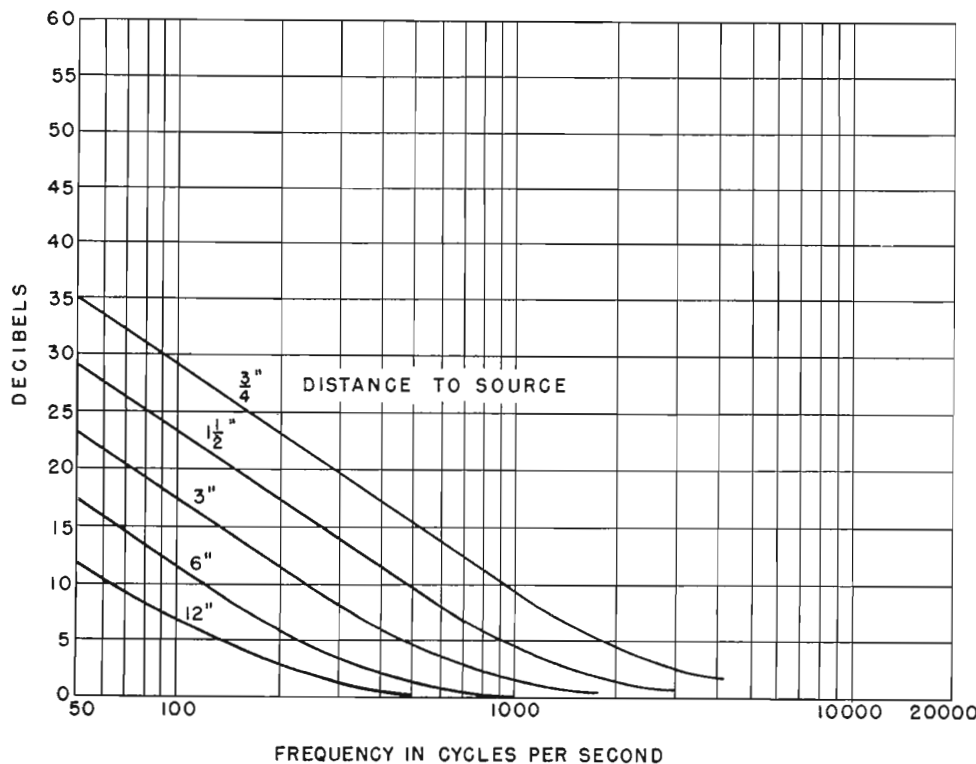

FIG. 5 (at left). Curves showing the effect of source proximity on velocity microphone response.

The output level from the microphone is high because of the efficiency of the generating element and the fact that the small size allows the speaker to get very close to it. In some cases it has been found desirable to introduce attenuation between the microphone and the preamplifier in order to prevent overloading of the amplifier with resulting distortion.

As can be seen from the data presented, we now have available for the first time a close-talking, high-fidelity microphone (RCA Type KB-3A) having a high output level and exceptionally good discrimination characteristics over a wide frequency range. One television broadcaster has successfully used the microphone on an audience participation program under conditions where usual microphones gave unsatisfactory performance because of acoustic feedback in an associated P.A. system. Its use in a ball park and a race track has resulted in higher acoustic gains than were formerly obtained with pressure microphones in sound booths of expensive construction. The KB-3A microphone was also used with success at a large technical society session where questions from the floor were transmitted to a speaker system from a portable microphone. Microphones commonly used resulted in feedback before adequate acoustic gain was obtained.

These are only a few of the possibilities, and this microphone should prove advantageous wherever a close-talking microphone can be used. The only restriction which need be remembered in extending the applications is that the microphone must be used at distances between $\frac{3}{4}$ and $1\frac{1}{2}$ inches from the source of speech if the discrimination advantages and fidelity are to be fully realized.

FIG. 7 (at right). Directional characteristics of the KB-3A "Close-Talk" Microphone.

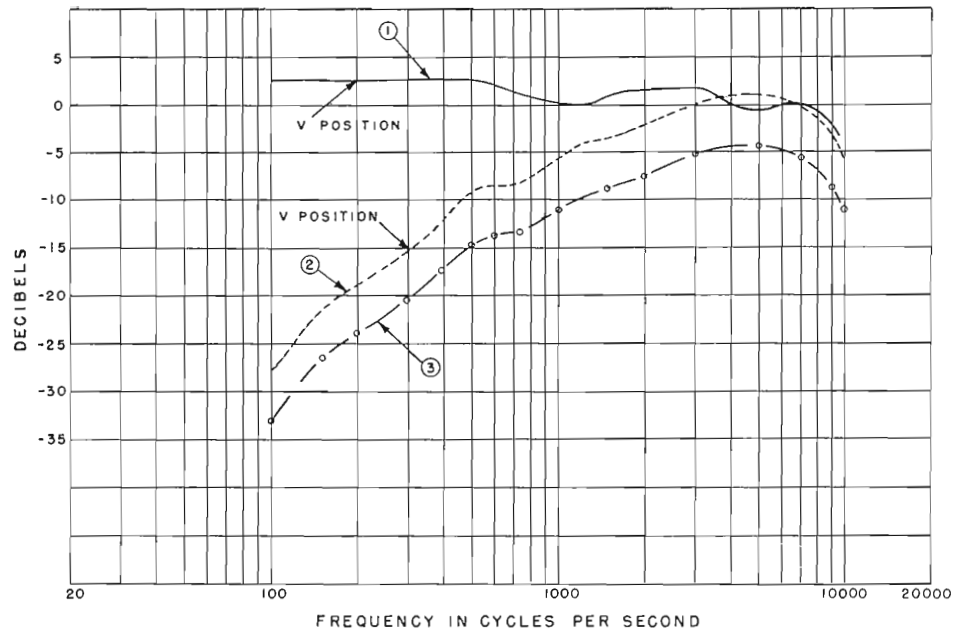
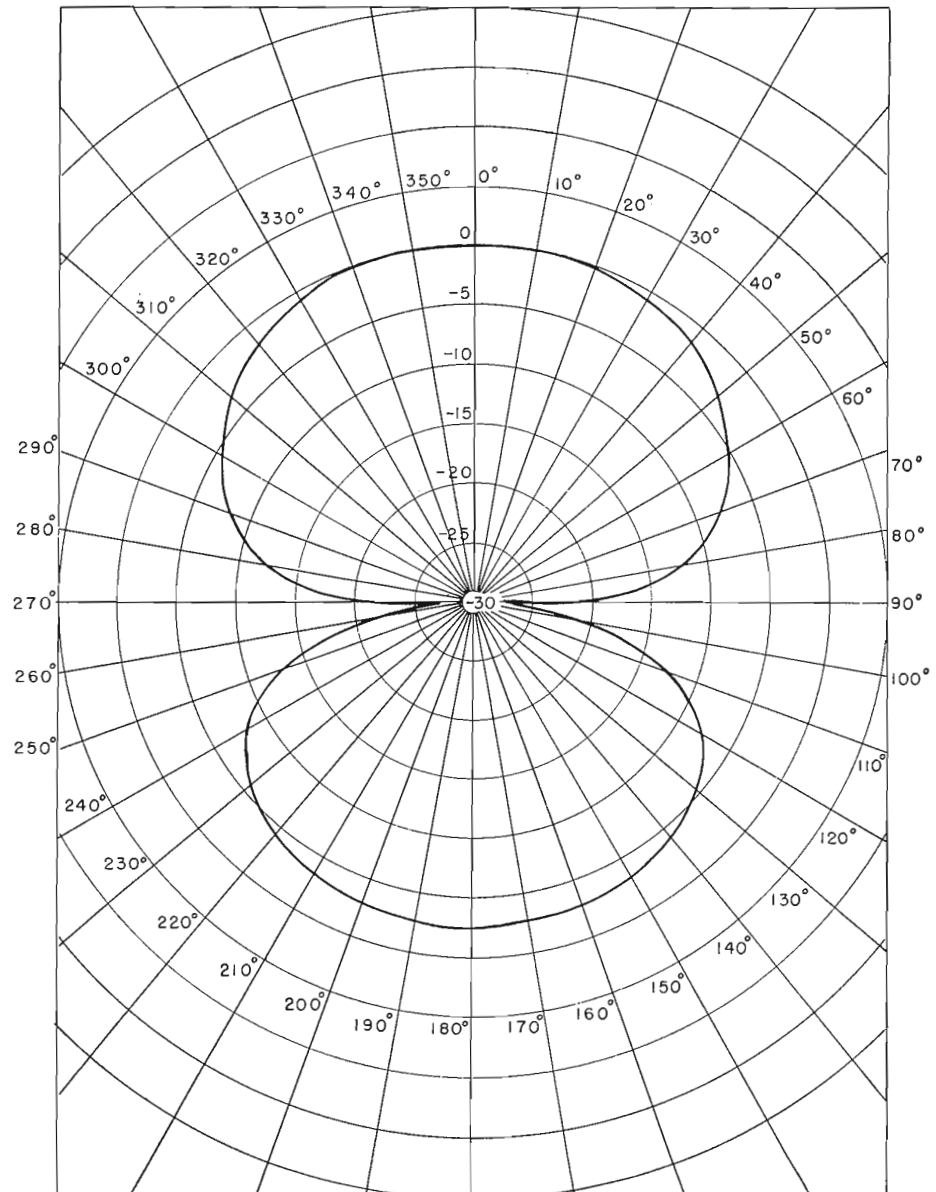

FIG. 6 (above). Measured response of the Type KB-3A "Close-Talk" Microphone.



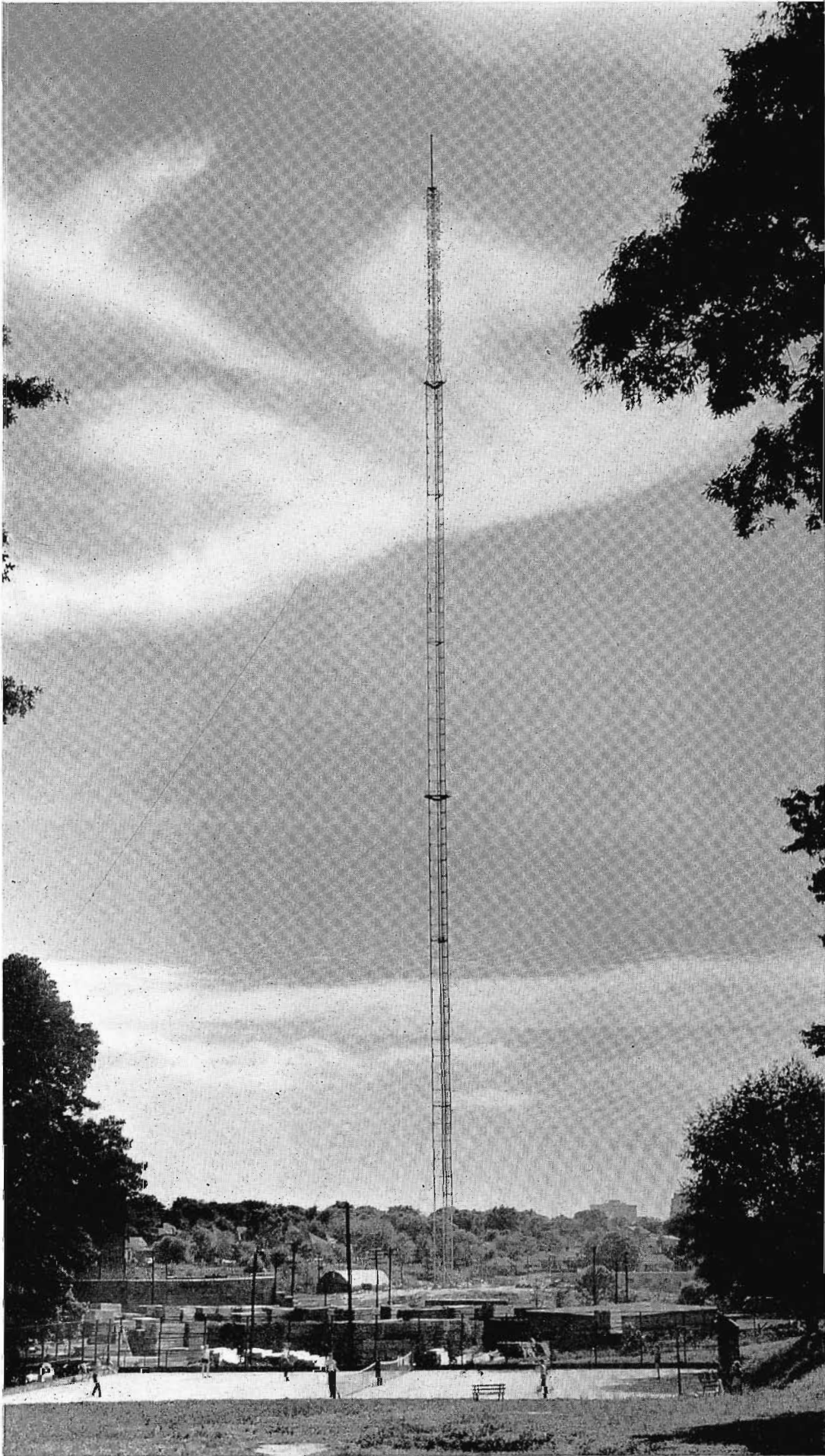
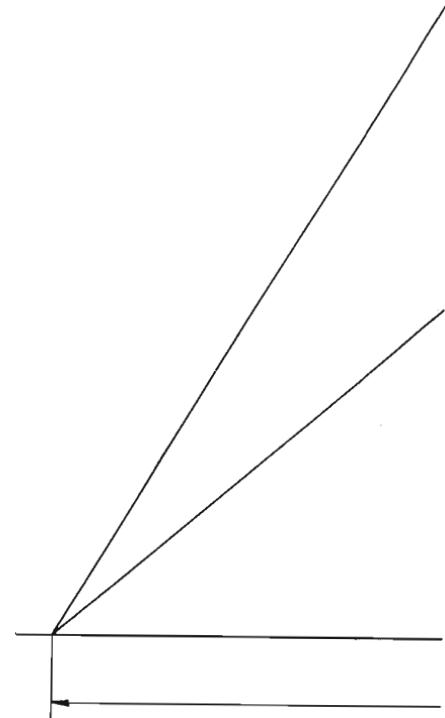
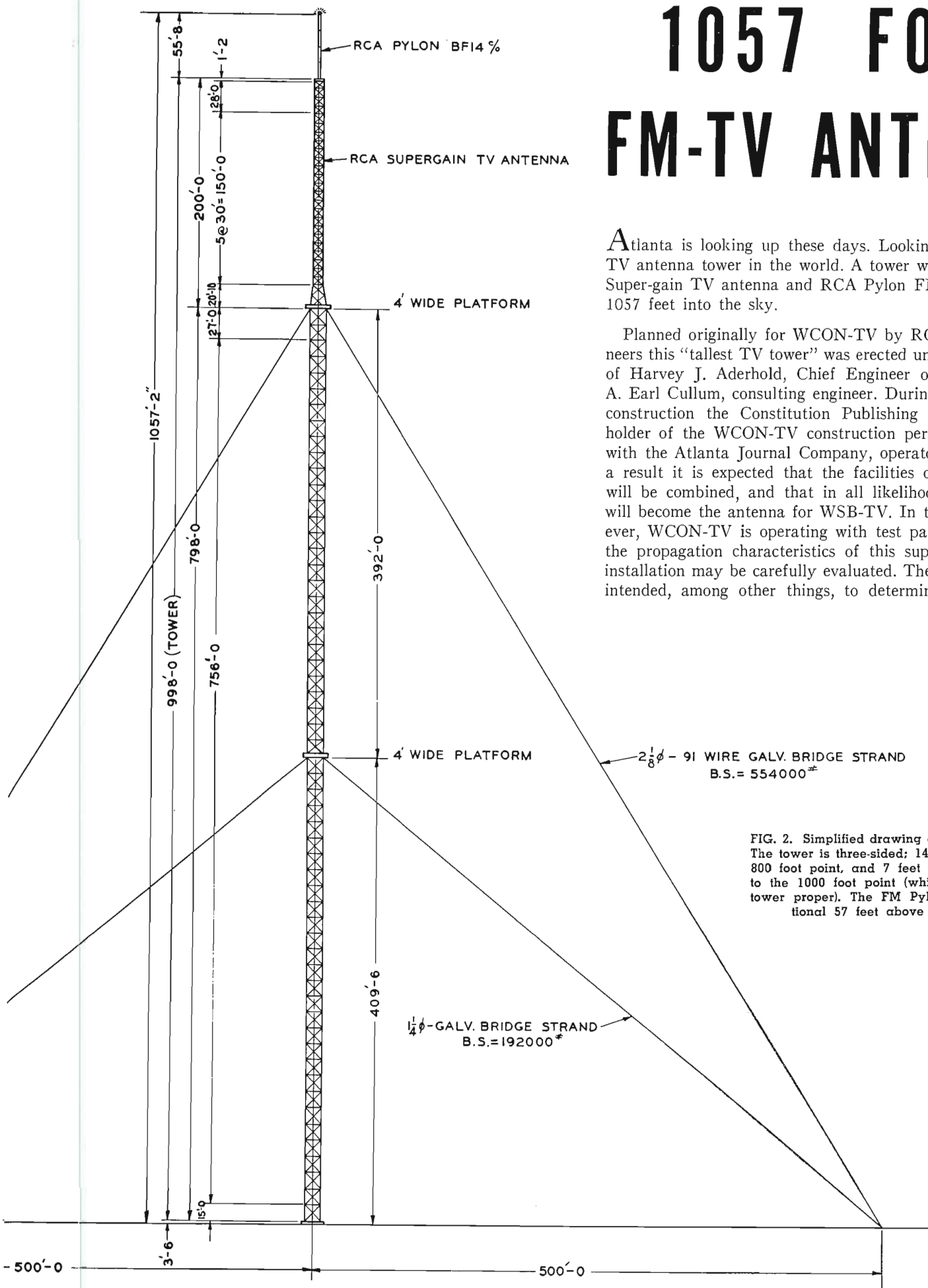

FIG. 1. View of the completed tower and antenna system from a point about a mile away. The location of the tower, in the very heart of Atlanta, provides high signal intensities in the city proper—while its tremendous height insures maximum coverage of surrounding areas.



1057 FOOT FM-TV ANTENNA



Atlanta is looking up these days. Looking up at the tallest TV antenna tower in the world. A tower which, with its RCA Super-gain TV antenna and RCA Pylon FM antenna, reaches 1057 feet into the sky.

Planned originally for WCON-TV by RCA and Ideco engineers this "tallest TV tower" was erected under the supervision of Harvey J. Aderhold, Chief Engineer of WCON-TV, and A. Earl Cullum, consulting engineer. During the course of the construction the Constitution Publishing Company, original holder of the WCON-TV construction permit, was combined with the Atlanta Journal Company, operator of WSB-TV. As a result it is expected that the facilities of the two stations will be combined, and that in all likelihood the giant tower will become the antenna for WSB-TV. In the meantime, however, WCON-TV is operating with test pattern in order that the propagation characteristics of this super-high, super-gain installation may be carefully evaluated. These tests, which are intended, among other things, to determine the interference

FIG. 2. Simplified drawing of the tower structure. The tower is three-sided; 14 feet on a side to the 800 foot point, and 7 feet on a side from there to the 1000 foot point (which is the top of the tower proper). The FM Pylon extends an additional 57 feet above the tower top.

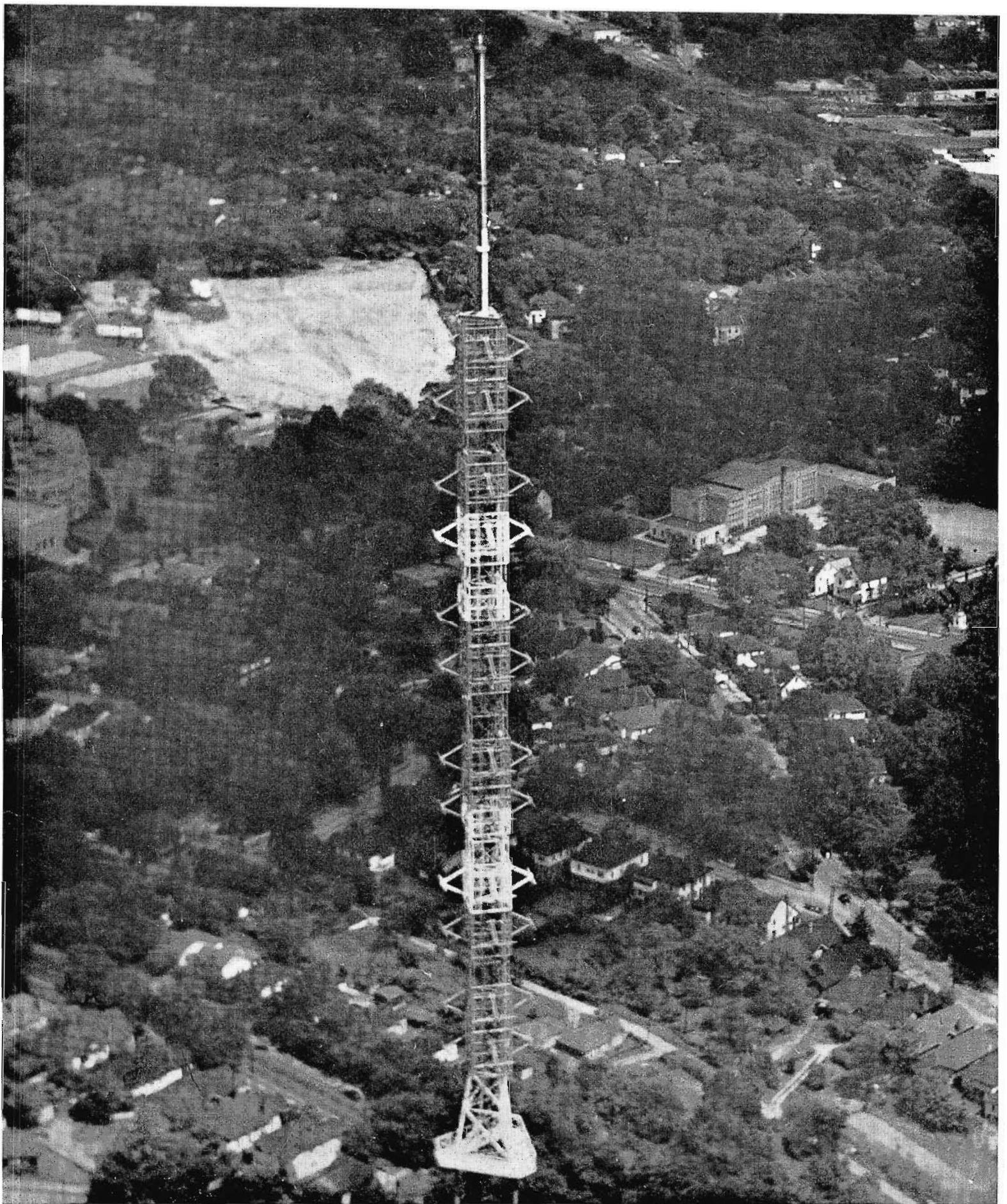
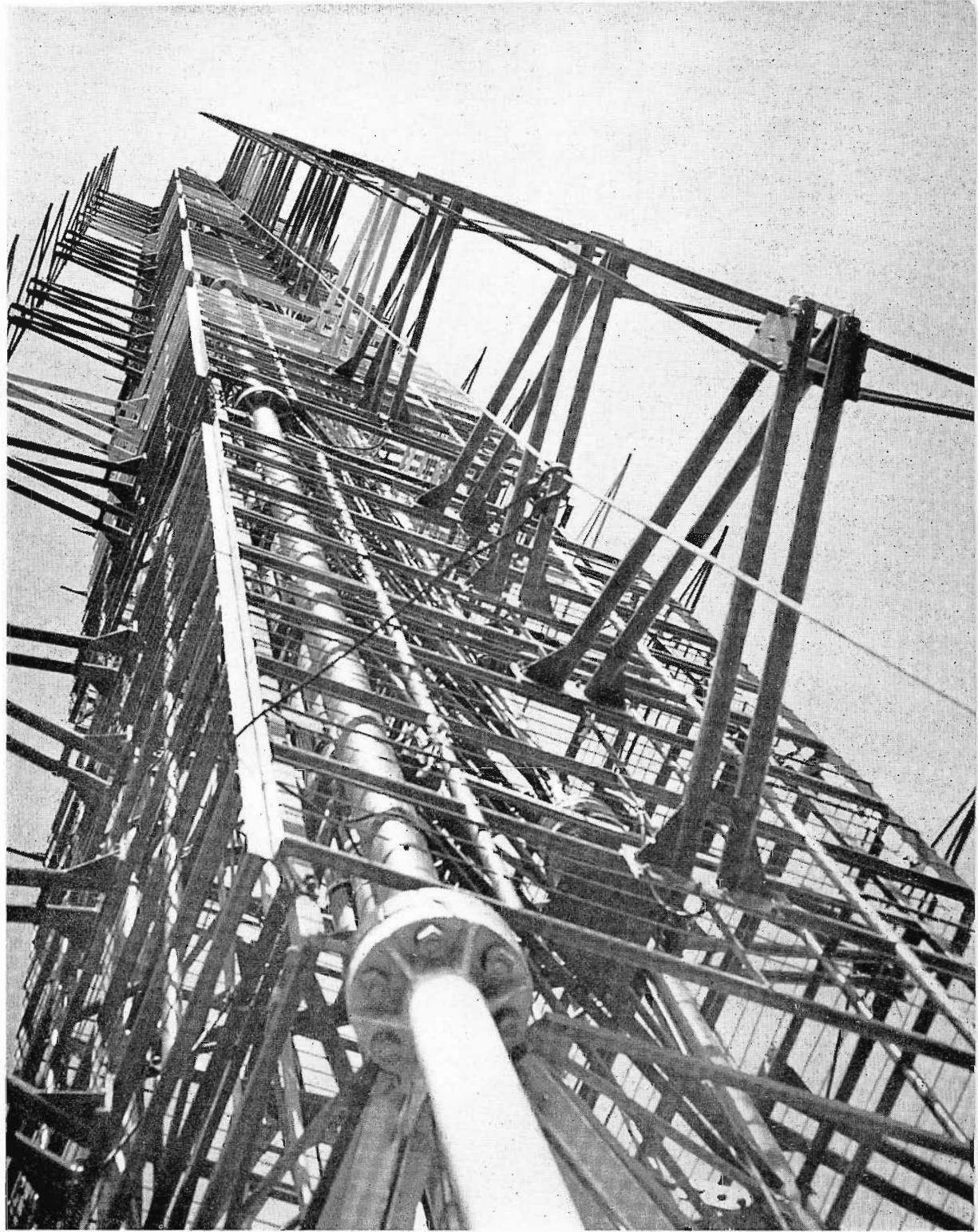

FIG. 3. The upper 200 feet of the tower proper—and the 60-foot Pylon—as seen from a low-flying plane. The RCA Supergain TV Antenna is mounted on this part of the tower. It consists of 48 radiating elements, each with its own reflector shield. These elements are mounted four to a layer, with the edges of the reflecting shields of each layer bolted together to form a square. This makes it look as if the upper part of the tower is four-sided. Actually this part of the tower, like the lower part, is of standard triangular construction.

FIG. 4. Looking up at the RCA Supergain TV Antenna from the platform at the 800 foot point. Each radiating element is a reinforced dipole which is fed power by a concentric transmission line running through one of the slanting supporting numbers. The method of assembling the "bedspring" reflective shields in a four-sided arrangement (around the three-sided tower) is evident in this view.



characteristics of tropospheric radiation on Channel 2, are being conducted under the general supervision of C. F. Daugherty, Chief Engineer, and Bob Holbrook, Assistant Chief Engineer of the WSB operations.

Towers approaching 1000 feet in height have been built before this—several of them. And, one or more of them were designed to support FM and TV antennas (as well as acting as AM radiators). However, the Atlanta tower is the first of more than 1000 feet; the first designed exclusively for FM and TV service (no AM)—and it is

the first to utilize a super-gain type TV antenna. This antenna, which consists of twelve layers of radiators, of the type described in the last issue of BROADCAST NEWS ("High Gain and Directional Antennas for Television Broadcasting," by L. J. Wolfe, Vol. No. 58, Pg. 46), has a gain of 11.5. This, with a 5 KW transmitter, and allowing for transmission line losses, will provide an effective radiated power of 52 KW. The FM antenna is a 4-section Pylon (RCA Type BF-14D) having a power gain of six. In the design of the tower provision was made for adding four additional sections at a later date

(which would bring the overall tower height to 1111 feet, and provide a gain of twelve for FM).

Another surprising feature of the "tallest TV tower" is the fact that it is not located "way out in the country"—as would be expected, but, practically speaking, right downtown. By very good fortune a 13-acre plot near the geographical center of Atlanta was obtained. This site is only one mile from "Five Points," the center of the city's business district. It is 973 feet above sea level—thus bring the total height of the tower to 2033 feet above sea level.

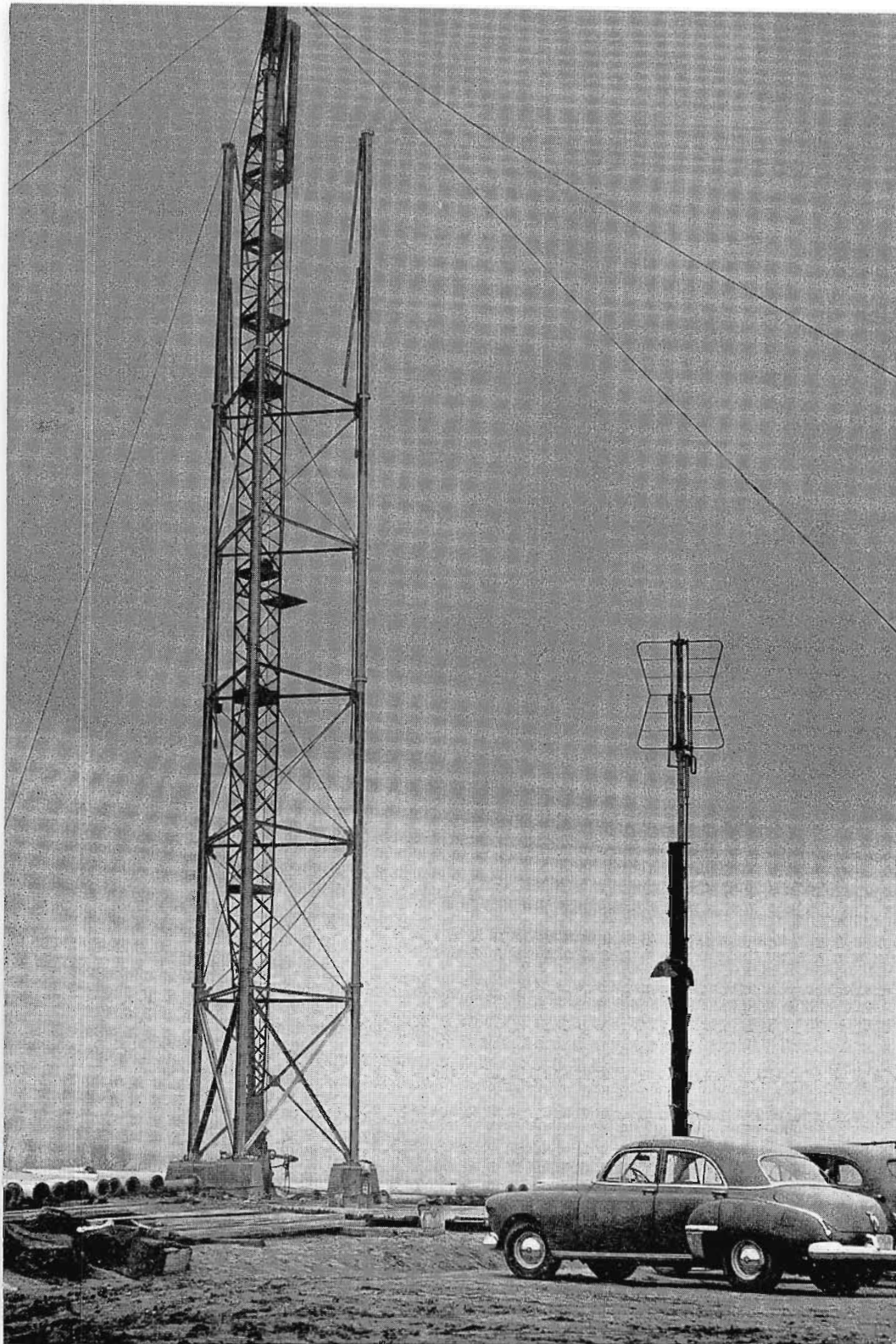

FIG. 5. A Chicago-type boom, 114 feet long and specially made for the job, was used in erecting the first 800 feet of the tower. This boom, which was "walked" up the inside of the tower as construction progressed, was replaced by a smaller boom for work above 800 feet. Temporary FM antenna may be seen (at right) in this picture.

The tower proper was constructed by Ideco (International Derrick and Equipment Company). Up to the 800 foot point it is 14 feet on a side. The outer members (legs) are $10\frac{3}{4}$ inches in diameter, with a wall thickness of $1\frac{1}{8}$ inches. Sections are 28 feet long; weigh approximately 5000 pounds a piece. Just above the 800 foot point the tower narrows to 7 feet on a side. Size of the corner members (which in this part are solid red) decreases in steps from 7 inches in diameter at 800

feet to $3\frac{3}{4}$ inches at 1000 feet. The total weight of the tower is 430,000 pounds.

The tower, antennas and transmission line systems were erected by the Beasley Construction Company of Muskogee, Oklahoma. The foundation is a solid block of concrete 28 feet across and hexagonal in shape. It contains 15,000 pounds of reinforcing steel and 283,500 pounds of concrete. The east and west guy anchors contain 5000 pounds of steel and 155,000

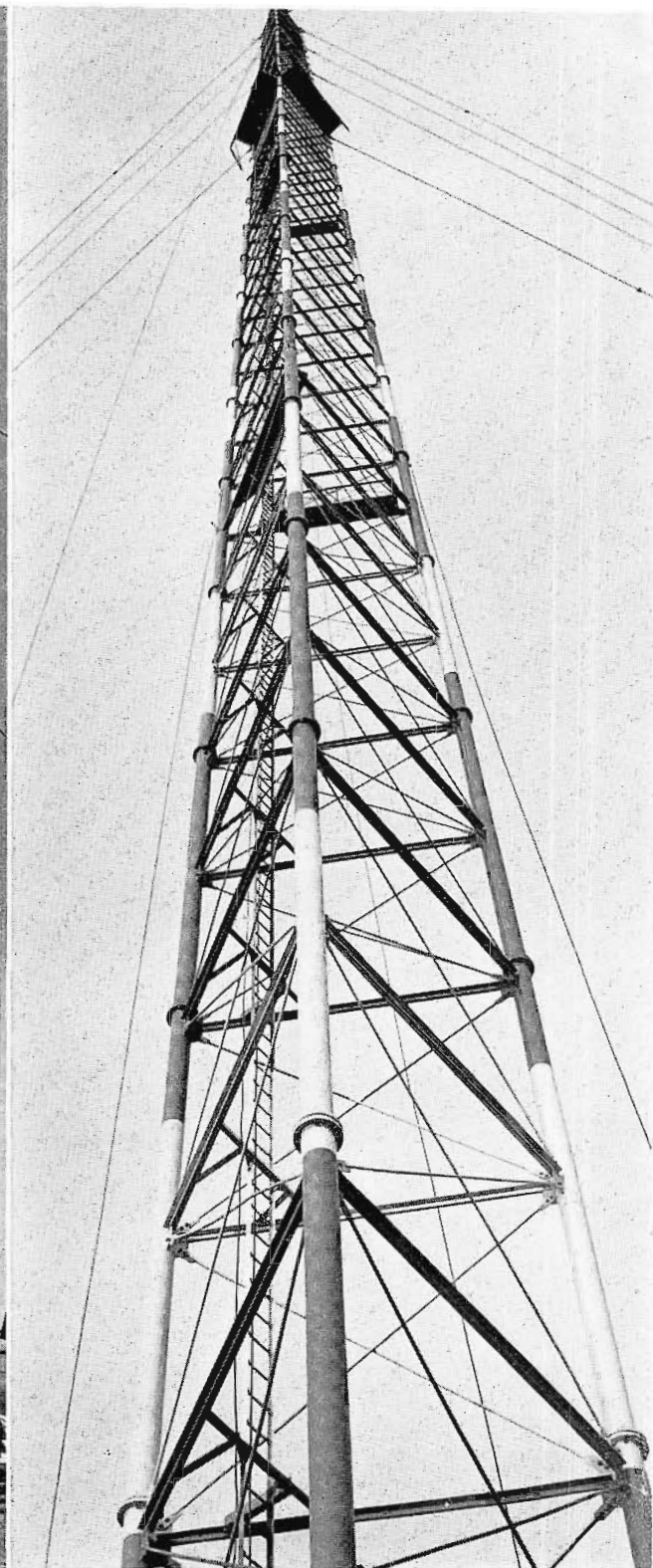

FIG. 6. Looking up the tower. (Temporary guy wires were still in place when this picture was made). Corner members of the tower, clearly seen here, are 10-inch tubing with $1\frac{1}{8}$ " thick walls.

pounds of concrete. The north guy anchor contains 6000 pounds of steel and 183,000 pounds of concrete.

The first set of guys, $1\frac{1}{4}$ inches in diameter, is connected at the 400 foot point and the second set of guys, $2\frac{1}{4}$ inches in diameter, at the 800 foot point. All guys, as well as all members of the tower proper, are hot dipped galvanized.

A feature of the tower, which will appeal to every operator who has had to replace

FIG. 7. Two 6 1/8" transmission lines—one for FM and one for TV—run up the inside of the tower. These lines are cable-supported, the method of anchoring being evident in this view.

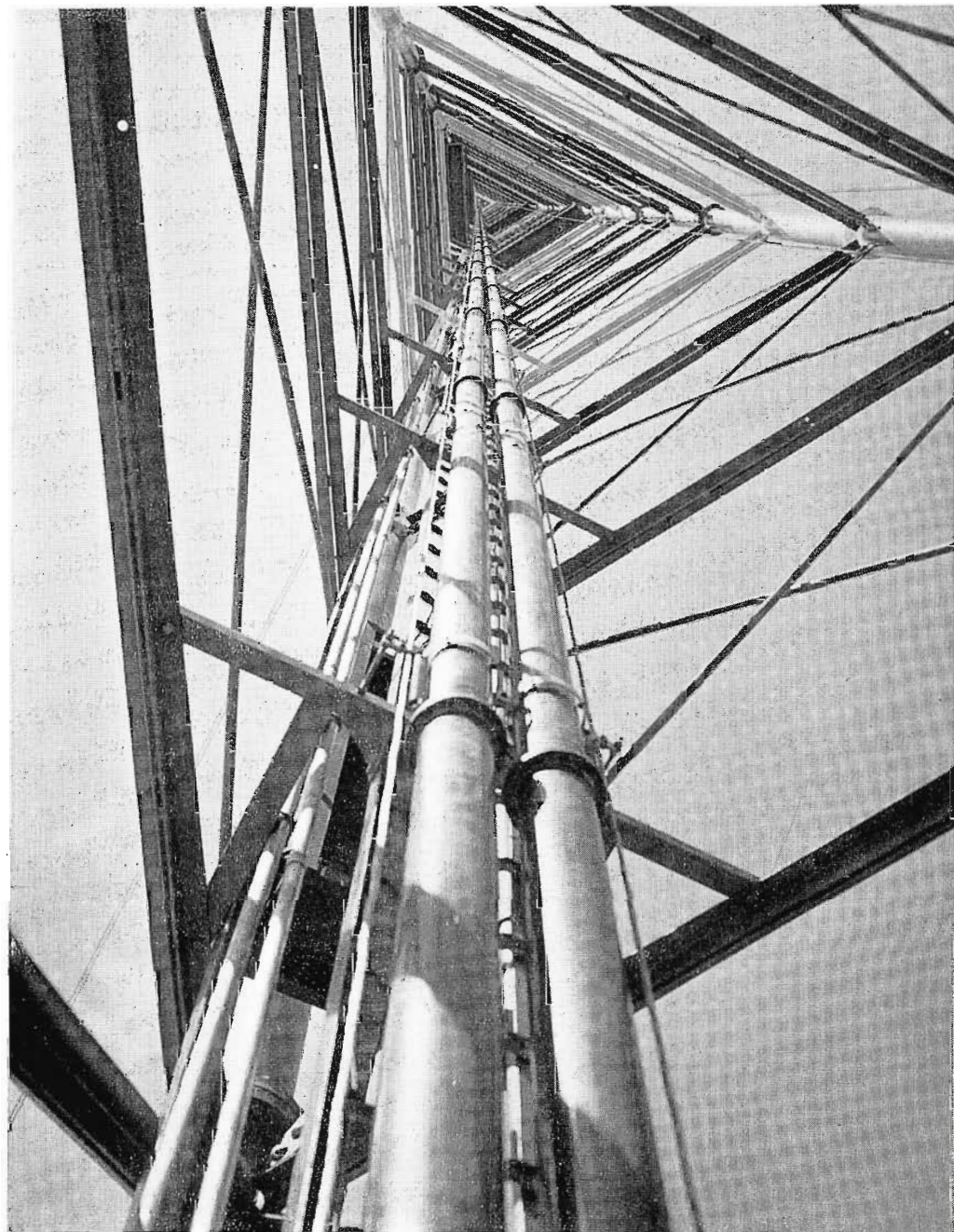

FIG. 8 (below). Bottom of tower, showing transmission lines going into building. This view, taken during construction, shows the lower end of the transmission line cable supports, as well as the lighting circuit conduits, the ladder, and the electric hoist (upper left-hand corner) which runs to the 800 foot point. Since the photo was taken, a corrugated steel shelter has been built over the horizontal sections of the transmission lines to protect them from falling ice, tools, etc.

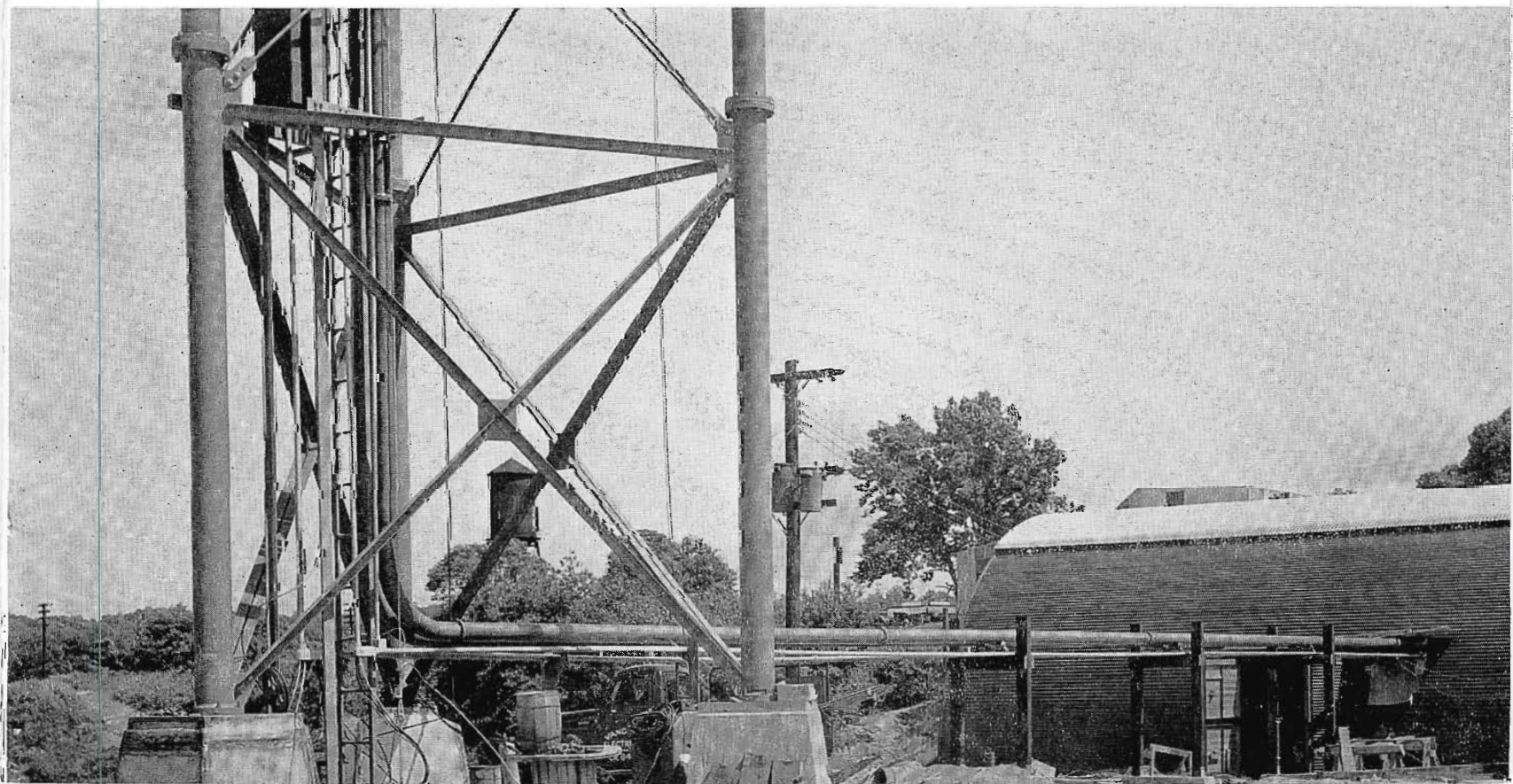



FIG. 9. The transmitter building is a modified Quonset, painted dark green and provided with brick trim which gives it a modern and pleasing appearance. In addition to the transmitter room it houses office, work shop, kitchen, storage space and rest room.

an obstruction light, is an electric hoist which runs to the platform at the 800 foot point. However, from this point on, brother, you're on your own, and it's a fifth of a mile to terra firma.

Tower lighting equipment includes fourteen obstruction lights and seven flashing beacons—about 10 KW in all. Photo electric equipment times lights on automatically whenever weather makes lighting necessary.

Lighting protection of an installation of this size makes proper grounding a necessity. Before the grounding system was designed a complete analysis of water tables and ground conductivity was made. The ground system—decided upon after this study was made—consists of copper

strap radials buried 6 to 8 inches and extending out 50 feet to copper ground rods spaced every five degrees. Copper caps over the concrete foundations are tied to this ground system and to the tower. As an added precaution three eight-foot lightning rods are mounted on the top beacon of the tower.

Adjacent to the tower is the transmitter building, as modern and as efficient in design and operation as the tower. The Quonset-type, all steel construction is 32 by 60 feet, providing 2000 square feet of space. From the outside, the building is a dark green. Inside it is an interior decorator's paradise. The control room features curved sereated plywood walls of light green, a Versa-Tile floor of misty green and ivory with deep red trim. Yellow

venetian blinds blend with the harmonious combination. The FM and TV transmitters are installed, leaving room for future expansion. The engineers work in air conditioned comfort in summer . . . an automatically heated building in the winter. Automatic ventilation for the FM and TV transmitters prevents over-heating of the control room. The building is completely insulated.

Another feature of the transmitter building is the concrete floor with duct work to all equipment, eliminating the necessity for conduits now or in the future. In addition to the modern, efficient control room, the transmitter building has office space, a kitchen, a complete workshop, storage space, and a rest room.

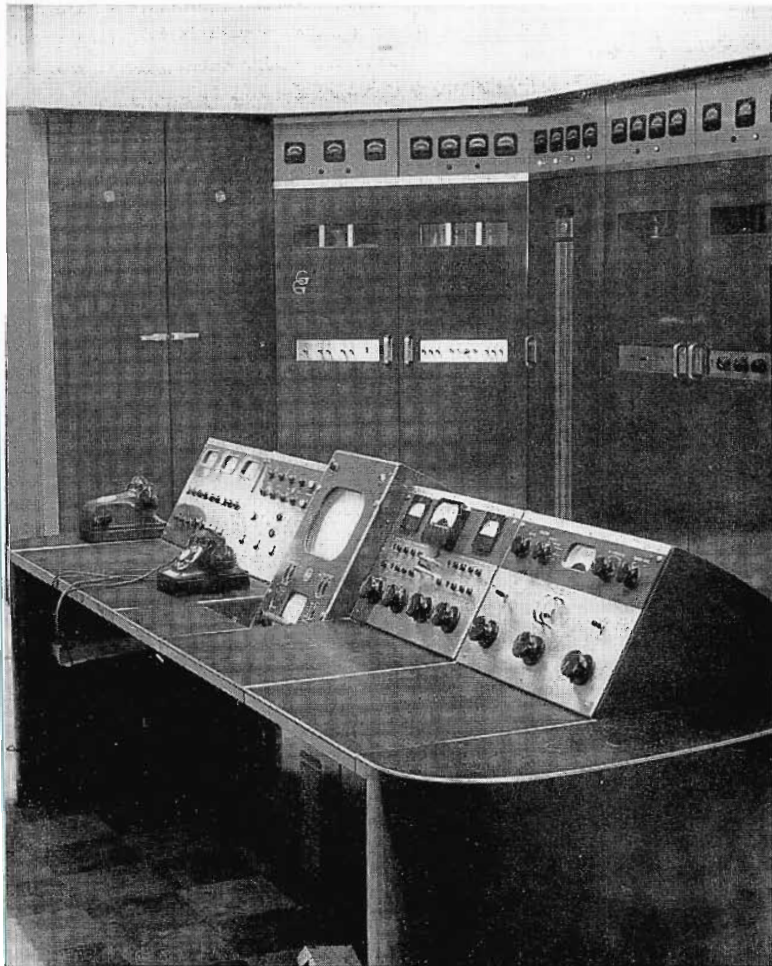

FIG. 10 (above). The 10 KW RCA FM Transmitter and the 5 KW RCA TV Transmitter are arranged in line with the left and right ends, respectively, bent around so that the equipment units form a shallow U. In the center of the U is the combined control desk. The view above shows the control desk and left side of the FM transmitter.

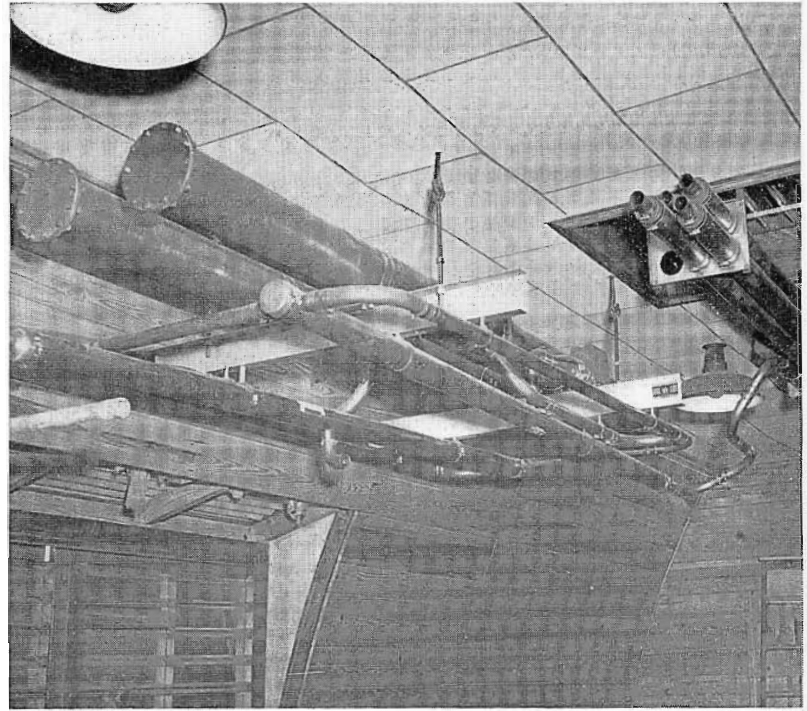

FIG. 12. The Notch Diplexer and Side-Band Filter in the TV transmission line are ceiling mounted units of the new simplified design.

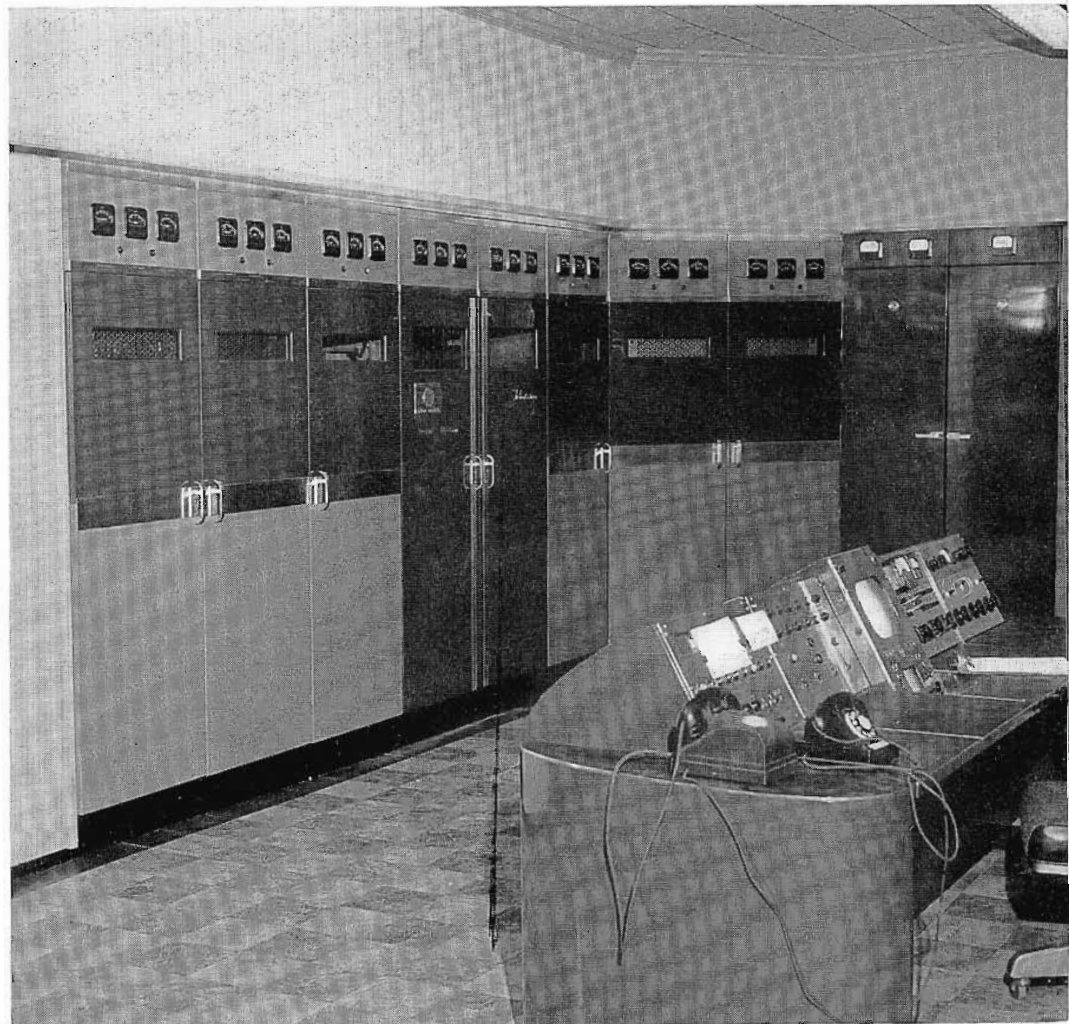

FIG. 11 (right). The view at right shows the control desk and TV transmitter which is at the right of the U. The transmitter room walls are serrated plywood in tan finish, the floor is Versa-Tile in ivory and green with dark red trim. Recessed lighting over transmitter panels makes meter reading easy.

COMBINING TV TRANSMITTER CONTROL AND PROGRAM SWITCHING

By **W. L. LYNDON** and **W. T. DOUGLAS, JR.**
Engineering Products Department

Two new control systems each designed to centralize TV program switching and transmitter control facilities are being used by a number of TV stations already on the air.

Known as the TTC-3A1 Audio-Video Control Console and the MI-19063 Audio-Video Switching Turret, both these systems have proved very useful to operating TV stations, as well as those just getting started. Those anxious to get on the air at the earliest possible date are employing one or the other of the systems upon installation of the transmitter and film facilities to provide an immediate method of audio-video switching between film and other sources of programs such as field pickups and network programs. The new switching system can be the sole means for program switching, prior to the construction of studios and control rooms. For TV stations with completed studios and control rooms, it can provide for switching between slides or test patterns and remote

shows during periods when studios are idle or being used for rehearsal. It is also useful where the transmitter location is remote from the studios, and where relay, network, and film available at the transmitter location, can be more conveniently previewed and switched to the transmitter at this location.

TTC-3A1 Control Console

Stepping beyond the realm of being merely an audio control unit the TTC-3A1 control console provides a compact and efficient control that places a television system on the air with the minimum of equipment and operating personnel. Additional built-in features provide a certain degree of expansion. If a TV station makes its debut showing motion picture film, opaque and transparent slide service with additional audio and video facilities provided in the console, the system may be expanded for use with either a relay circuit or coaxial cable service, or both, whenever they become available.

The control circuits and a few of the associated components are housed in a self-contained console having a turret with a hinged sloping front panel. The basic console is one of a standard RCA design that will permit it to be mounted adjacent to such units as the TK-20A film camera control unit, and a TM-5B master monitor, and a finished appearance is achieved by adding a right hand and left hand end section. Such a combination of units is shown in Fig. 3.

The essential controls are located on the hinged front panel of the turret (Fig. 2). The auxiliary units such as relays, audio monitor level equalizer potentiometers, isolation transformer, pre-emphasis network and chopper circuit are located within the turret. The base of the unit houses a dry type rectifier for relay and pilot light power supply. It also contains the audio, video, and power control circuit terminations. A close up view of the control panel

FIG. 1. Complete TV transmitter console which provides program switching and transmitter control. Two right hand units are film camera control and the MI-19063 Program Switching Turret. Left three units constitute standard TT-5A transmitter console.

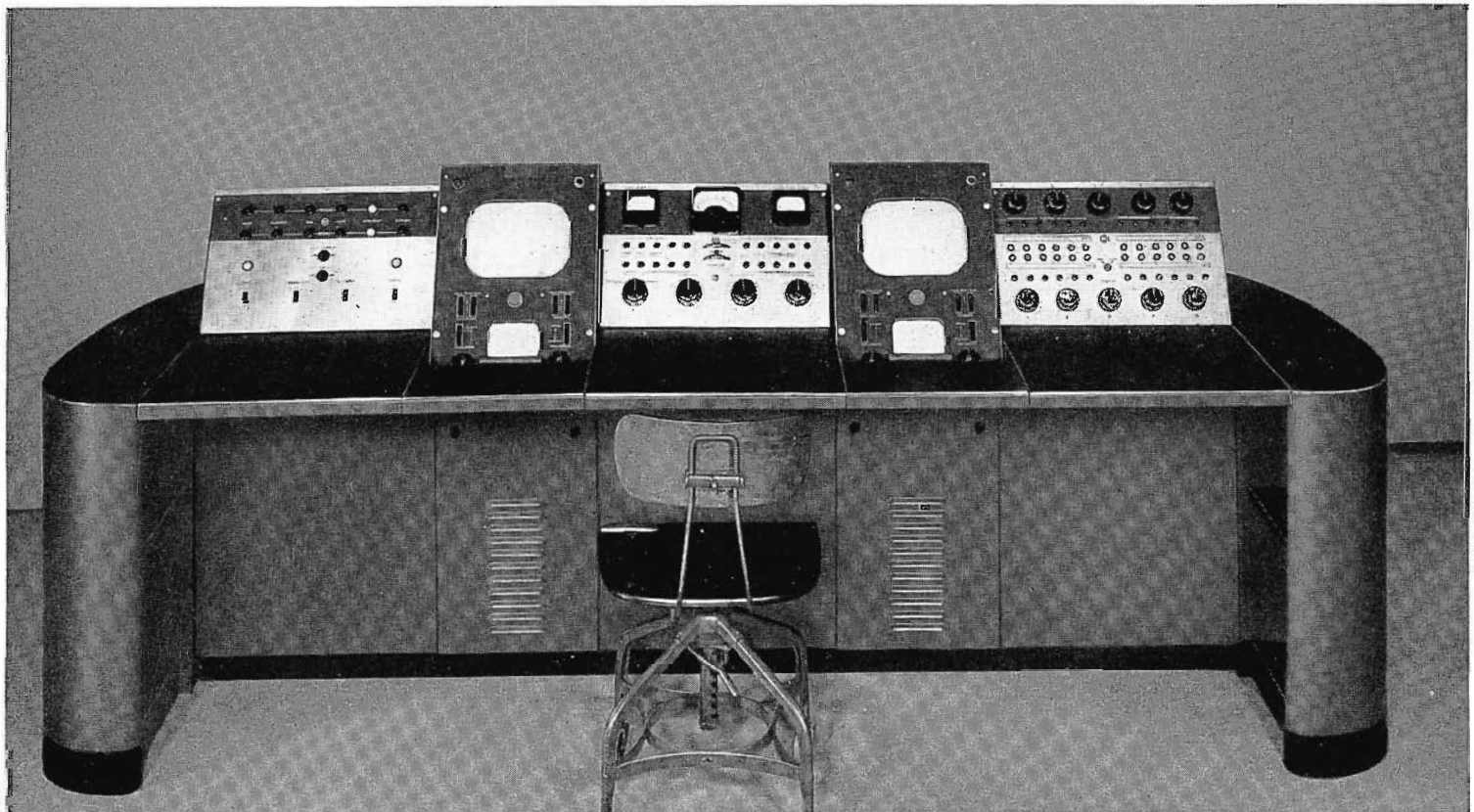

is shown in Fig. 3. In order to simplify the operation of this panel, the various controls have been functionally grouped.

The upper left corner contains the controls for a transparent slide projector. These controls consist of an ON-OFF power switch with associated indicating pilot light, a variable unit which permits control of the projector lamp supply and a push button switch designated as OPERATE. This switch may be used as a means of controlling remotely operated slide changing devices.

The top center of the panel contains a standard VU level indicating meter. The multiplier for this meter is a semi-adjustable type and can be set to read any level from +4 to +31 VU by reconnecting the control unit.

Normally TV stations whose programming is devoted almost entirely to the showing of motion picture films will require the services of two picture projectors, preferably of the 16 MM type because of the wide variety of film that is available. In the upper right hand corner of the control panel are located the controls and indicator lights for two 16 MM motion picture projectors. After the projectors themselves have been placed in an operating condition their controls are thrown to the remote position. This arrangement makes it possible to start-stop and change over from one projector to the other from the TTC-3A1 console. The audio output of the two projectors terminate in a relay, which in turn is controlled by the projector change-over switch. The output of this relay is connected to the film position of

a four-position audio selector switch designated as FILM, NET, REMOTE, SPARE. The picture output of the two projectors feed into one film camera, and its control unit. The video output of the film camera control unit which would be mounted adjacent to the TTC-3A1 console would feed by means of coaxial cable to the film position of the picture program switch designated as FILM, NET, RELAY, SPARE 1 and SPARE 2. This switch has its positions mechanically interlocked so that it is possible to obtain only one source of picture on the outgoing video program bus. Each projector is provided with a dowsing unit mounted in front of the projector lens, thus, whenever a machine is placed in operation, the sound and picture are transferred simultaneously.

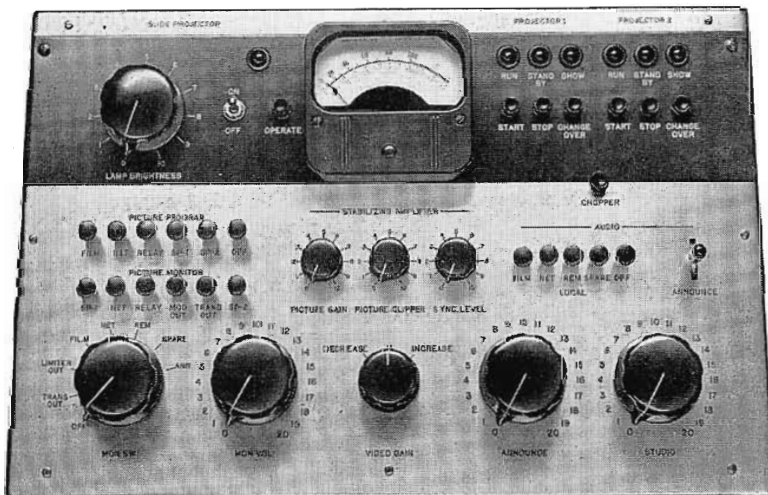
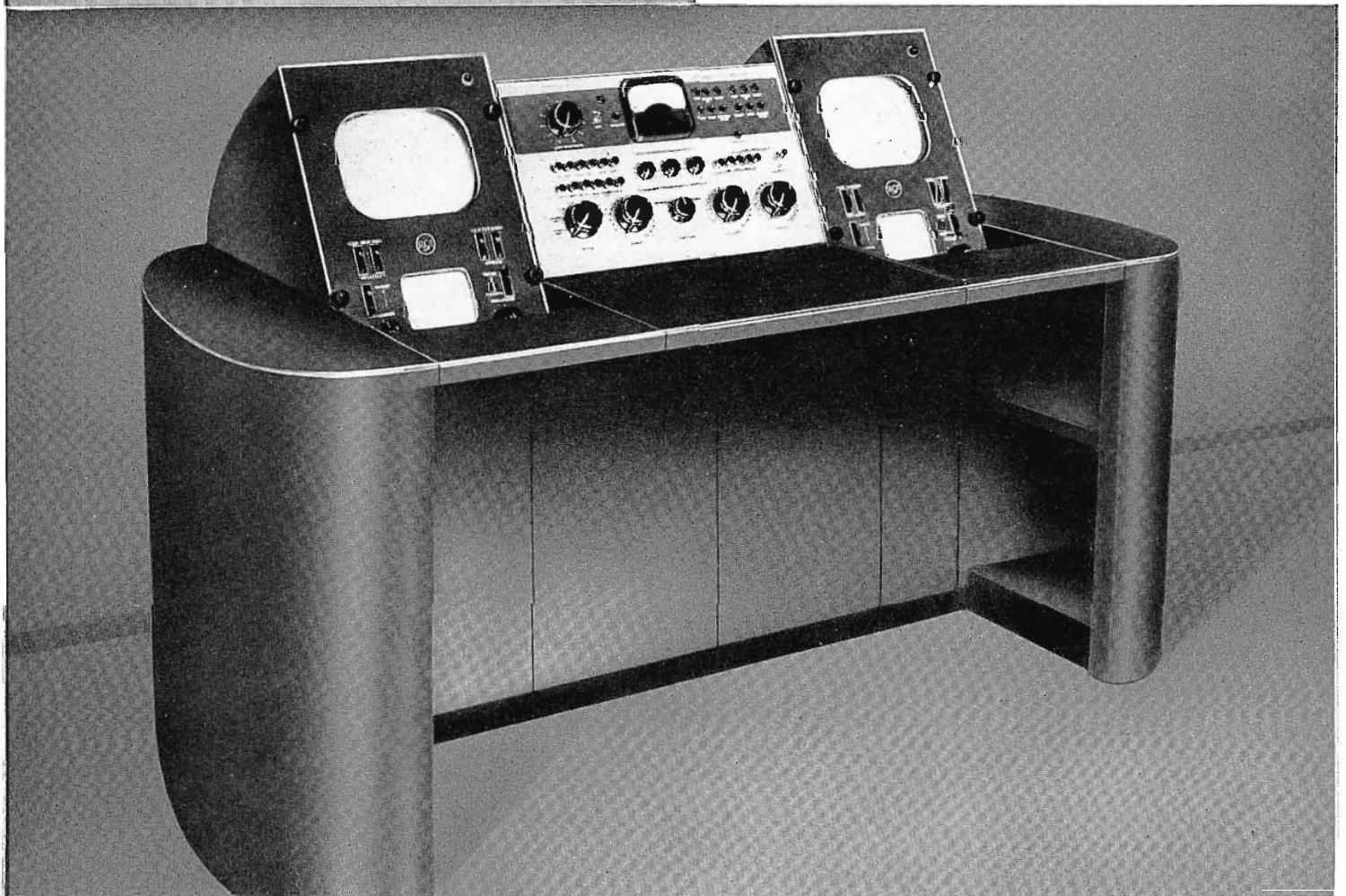
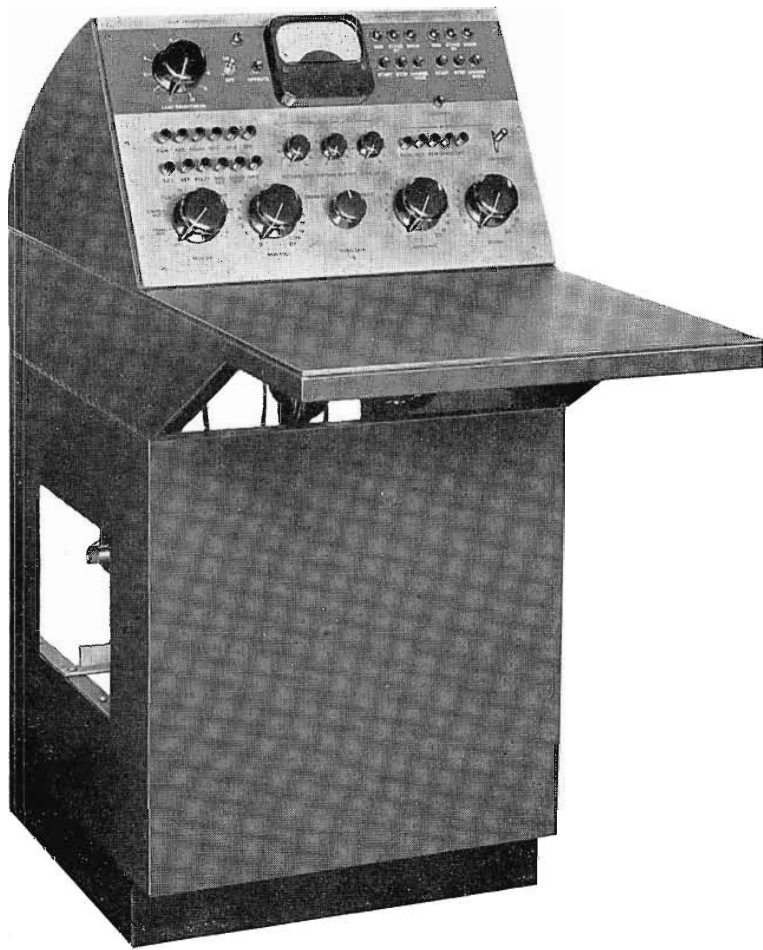

FIG. 2. Panel of TTC-3A1 Program Switching System. On this panel are controls for program levels, switches for audio-video selection and for remote control of two film projectors, plus a transmitter VU meter.

FIG. 3. Transmitter console made up of TTC-3A1 Switching System (center) plus on-air monitor (left) and film camera control. TTC-3A1 system differs basically from MI-19063 (Fig. 1) in that it requires incoming signals of standard levels.





Below the projector control switch is a pushbutton designated as CHOPPER. This button controls a vibrator which is operated from an AC power supply. The armature of this vibrator is connected to the picture monitor output position of the video transmitter, and is adjusted so that it intermittently shorts the monitor line. This monitoring circuit is switched to the input of the master monitor. It provides a means of locating and adjusting the zero percent of modulation.

Directly below the CHOPPER switch is a mechanically interlocked pushbutton switch used for the termination of four incoming audio sources referred to above. The output of this switch feeds into an audio attenuator designated as Program which regulates the level feeding the program bus. Adjacent to this switch is located a lever key switch which, when operated, feeds an announce circuit into an associated attenuator. The output of this announce and program circuit is combined to feed the program bus. The announcer key also controls a speaker relay, which when operated will remove the speaker to prevent acoustic feedback.

Directly below the VU meter are three controls which remotely control the essential adjustments of a Type TA-5C Stabilizing Amplifier. This amplifier is a highly desirable piece of equipment and adds much to the reproduction of pictures of

FIG. 4. TTC-3A1 Audio/Video Switching Console consists of a switching turret, desk section and relay/lamp power supply which is mounted in the desk.

FIG. 5. Block diagram showing audio and video facilities of the TTC-3A1 Switching System. Auxiliary equipment is shown in dotted lines.

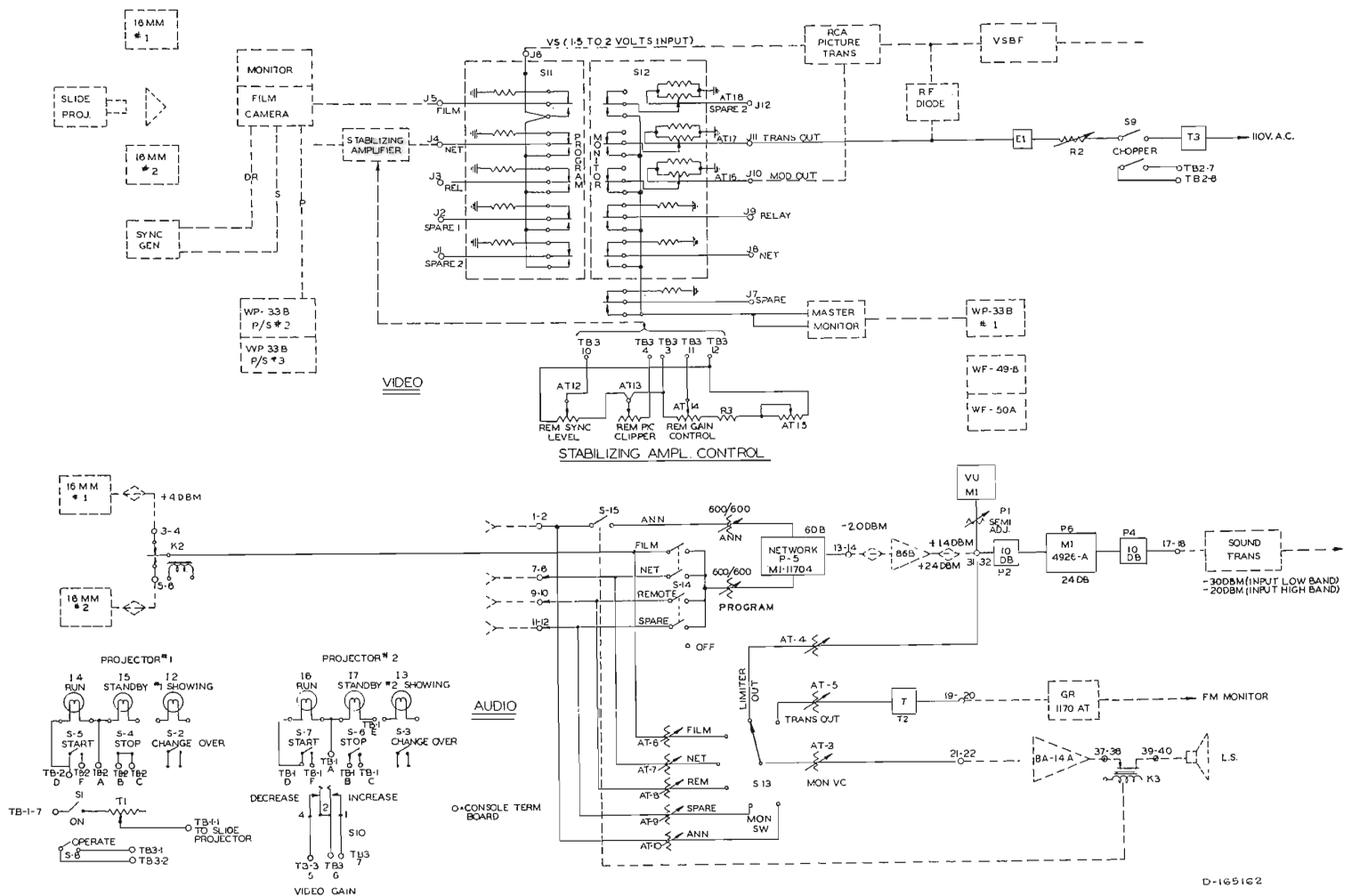

D-165162

high quality, especially if the pictures are received over relay or coaxial circuits. The three controls regulate the picture gain, picture clipper circuit, and the sync level. If the input of the stabilizing amplifier is terminated on a coaxial jack panel, it expands its usefulness by being able to be patched to a number of program circuits.

A video gain control for the picture transmitter is provided and is located directly below the three stabilizing amplifier units. This control is associated with a motor driven video volume control located within the transmitter. By switching the monitor output position of the picture transmitter to the input of the master monitor, it is possible to observe and adjust the picture being transmitted for the correct depth of modulation. No control unit would be complete without having monitoring facilities for the essential audio and video circuits.

The audio monitoring consists of a 7-position selector switch and a monitor volume control. It is possible to monitor the transmitter output, line amplifier, or limiter amplifier output, film, network, remote, spare line and announce position. On the input of each one of these monitor positions is a semi-adjustable volume control thus permitting the levels feeding the monitor switch to be equalized.

The video monitoring consists of a six position mechanically interlocked switch, the output of which is fed by means of

coaxial cable to the input of the master monitor, located adjacent to the TTC-3A1 control console. In addition to two spare positions on this switch, there are positions for monitoring such circuits as network, relay, modulator output and transmitter output. The inputs for both the picture program and monitor switches are terminated in coaxial cable plugs mounted within the base of the control unit. Three of the positions are provided with semi-adjustable terminations, thus making it possible to switch between these positions without any apparent change in video monitor level.

A block diagram of the TTC-3A1 is shown in Fig. 5. The circuits and components that are physically part of the desk are shown in solid lines. All external circuits and associated units are indicated by dotted lines. The upper half of the block diagram is devoted to the picture part of the system while the lower half covers the audio system and the 16 MM projector controls.

The video equipment consists of one transparent slide projector and two 16 MM motion picture projectors feeding into a film camera unit and its monitor. Two type WP-33B power supplies are associated with this camera and control chain. The sync generator which would normally be of the rack mounted type, supplies the drive and sync voltages for TK-20A film camera unit. The output of the camera control unit feeds to the input of the video program switch which in turn is connected

directly to the input of the picture transmitter. The picture transmitter may be an RCA 500 watt type TT-500A, TT-500B or a 5 KW unit type TT-5A. The RF output of the transmitter is terminated in a vestigial side-band filter before it is fed into an antenna system. Two monitoring positions are indicated, (1) the output of the transmitter modulator and (2) the rectified carrier output from an RF diode unit. The chopper action is applied to this latter circuit.

The master monitor is connected to the output of the video monitor switch. The input for all video program and monitoring circuits are provided with a 75 ohm termination. The type WF-49B and WF-50A are frequency monitor units for the picture transmitter. Directly below are the remote control units for the stabilizing amplifier.

The audio diagram indicates the sound output of the two 16 MM projectors as being connected directly to the program switch. The various circuit losses and required amplifier gain is indicated. In the case of the type TT-5A low band transmitter, it requires an input level of -30 dbm, whereas for the TT-5A high band transmitter, the input level required is -20 dbm. The inputs for the announce, network, remote and spare positions are indicated as being terminated on jacks, and no reference is made to any preceding audio amplifying units. This has been left in this manner because the type and

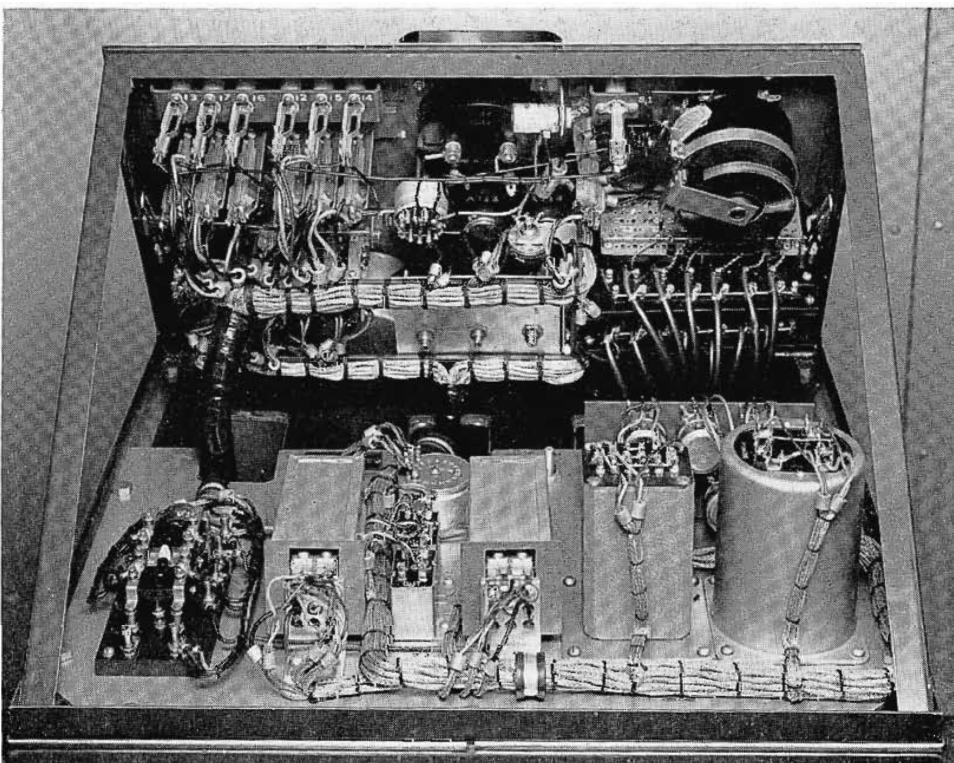

FIG. 6. Cover removed to show view into rear of turret. Variac in upper right corner remotely controls projector lamp brightness.

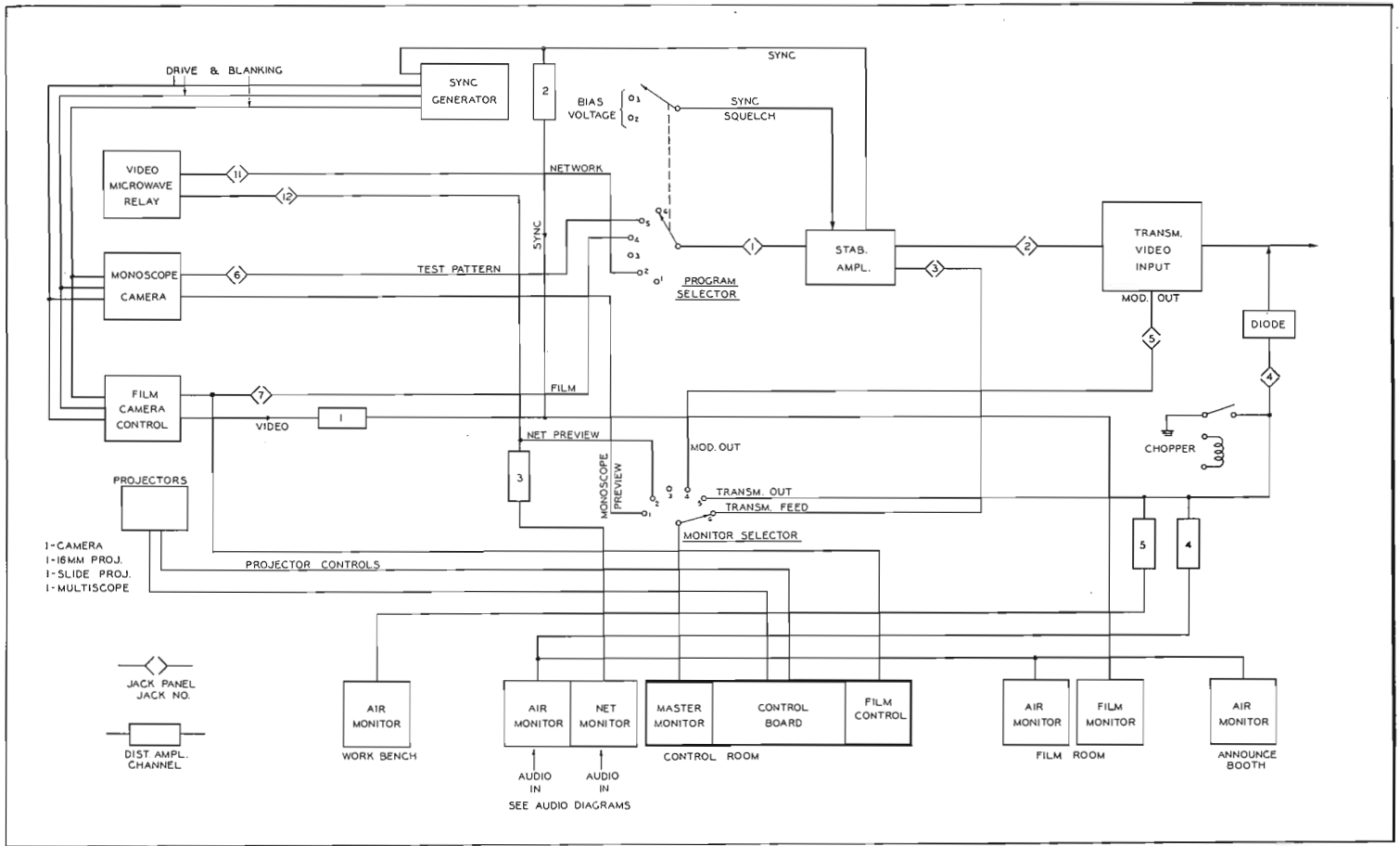
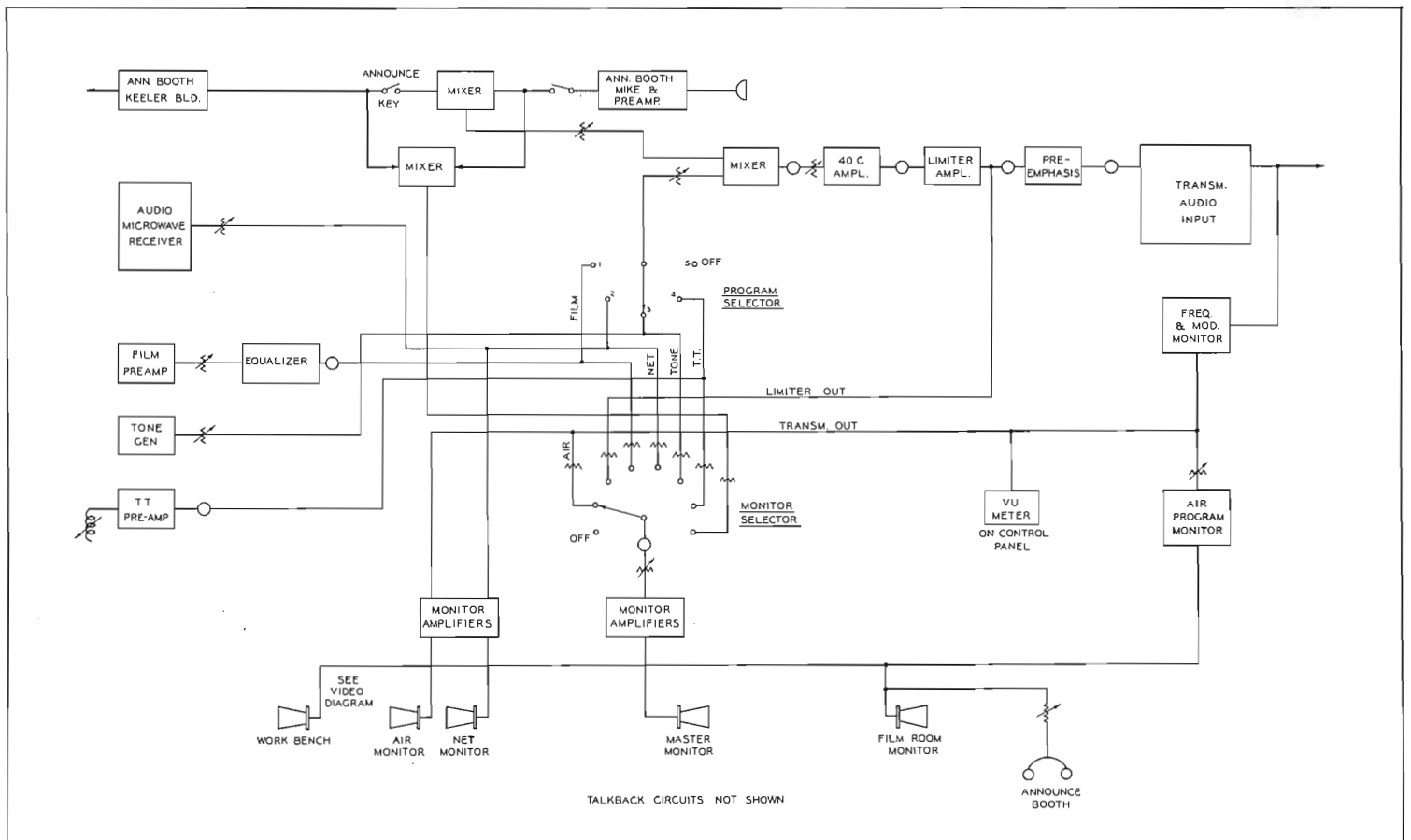

FIG. 7. Block diagrams showing audio and video switching facilities in the transmitter room of WLAV-TV. Incoming signals are from microwave relay, monoscope camera, film, turntables, announce and tone generator.



quantity of units required depend upon the type of service to be provided. The input level required for each of these three positions is +4 dbm which has been established by the normal audio output supplied by the projectors.

For the announce circuit, an OP-6 or a BN-2A portable amplifier can be used to advantage. The BN-2A has additional inputs which could be used for transcription service. Amplification for the network and remote lines can be conveniently provided by the use of a type BA-13A program amplifier. The addition of a 33-A jack panel, a line equalizer and an MI-11265 VU meter panel will provide a very flexible arrangement for equalizing, amplifying and determining the correct audio level to be fed into the audio program switching circuit. An MI-26313 film equalizer has not been indicated. It would normally be connected into the common lead feeding the program switch. This equalizer has an adjustable high and low frequency response and can be of considerable assistance in correcting the variable recording characteristics which may be encountered in 16 MM film.

The facilities incorporated in the TTC-3A1 audio video control console are sufficient to permit a television station to be placed in service with the minimum of equipment and operating personnel and it contains additional facilities which will permit a certain degree of facility expansion. However, should the station expand to the point of adding a television studio, where direct pickup will be made, the audio system must, of course, be reconsidered on the basis of the type of programs that are expected to be reproduced.

MI-19063 Audio-Video Switching Turret

The MI-19063 Audio-Video switching system is a turret only, but it is designed for mounting in a desk section (MI-28401-1) so that it can be used in conjunction with a master monitor for previewing. The system differs from the TTC-3A1 in that it incorporates fader controls for adjusting video levels, for program and preview. The TTC-3A1 requires level-setting and fading of video signals prior to reaching the console. A block diagram of the MI-19063 system is shown in Fig. 9. The TA-5B(C) Stabilizing Amplifiers and TA-10A Mixing Amplifiers are used for mixing and fading of video signals. The TA-1A Distribution Amplifiers, which can be mounted in the desk, are used for isolation.

All switching is accomplished by push-button switches arranged so that the normally associated picture and sound push

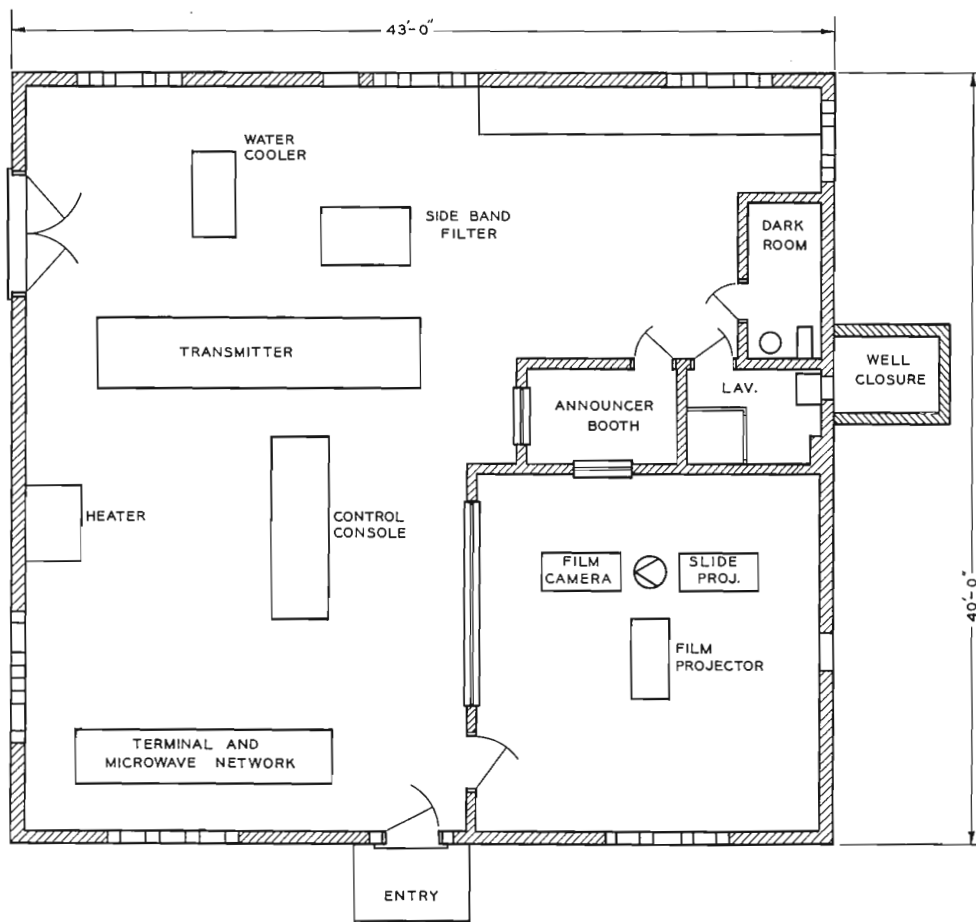
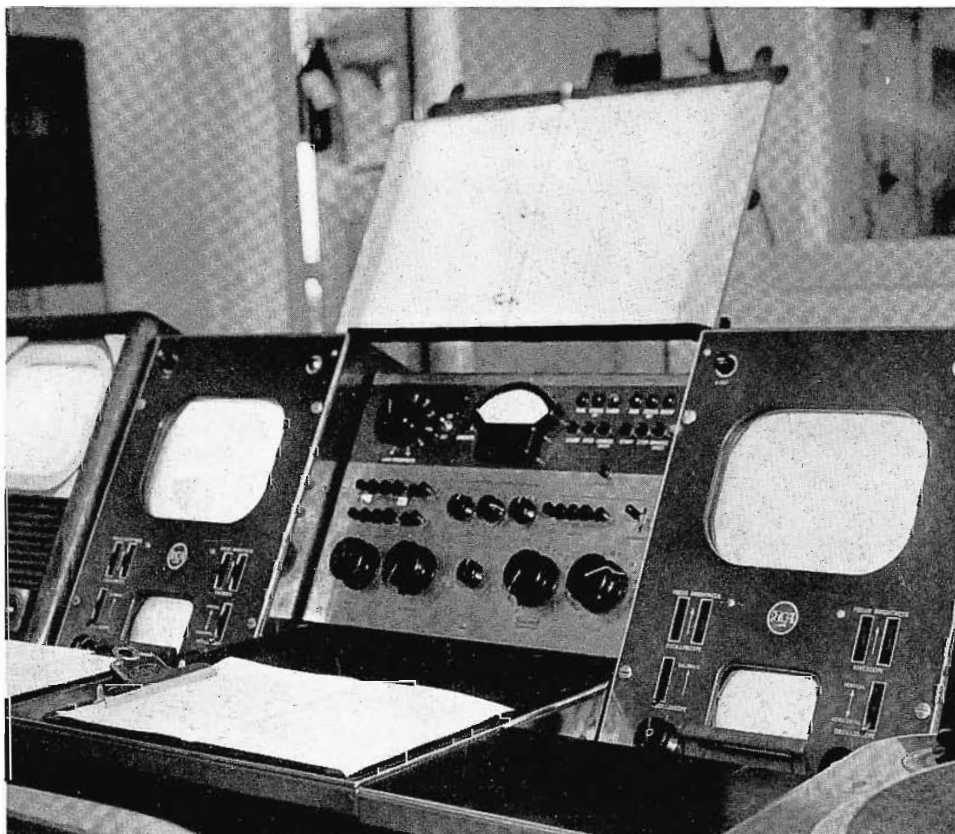

FIG. 8 (below). View of the TTC-3A switching console of WLAV-TV, Grand Rapids, Mich. Preview and on-air monitors are installed on either side. The location of the console with respect to the RCA TT-5A TV transmitter is shown in the floor-plan diagram above. See Fig. 7 for audio and video block diagrams.



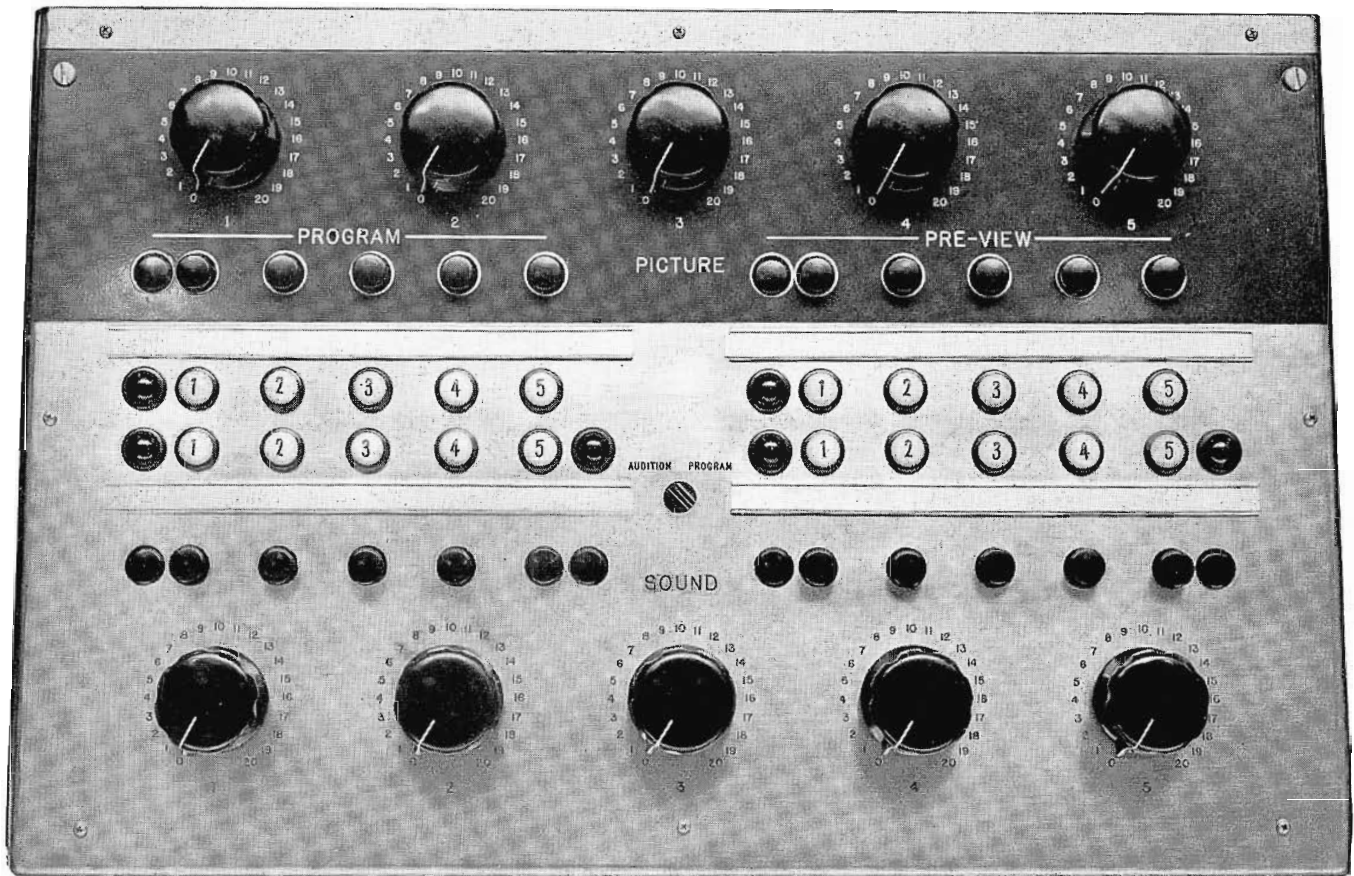
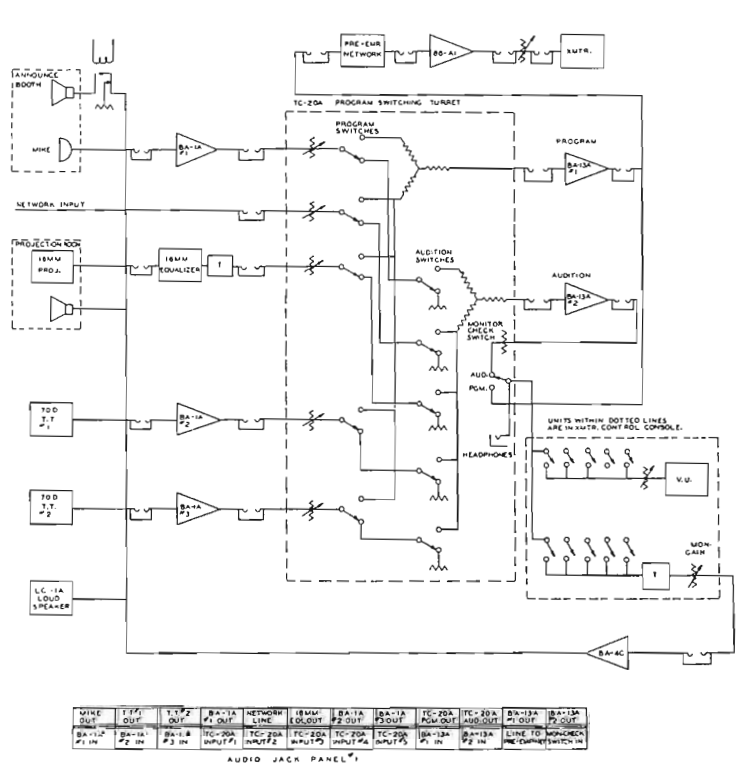
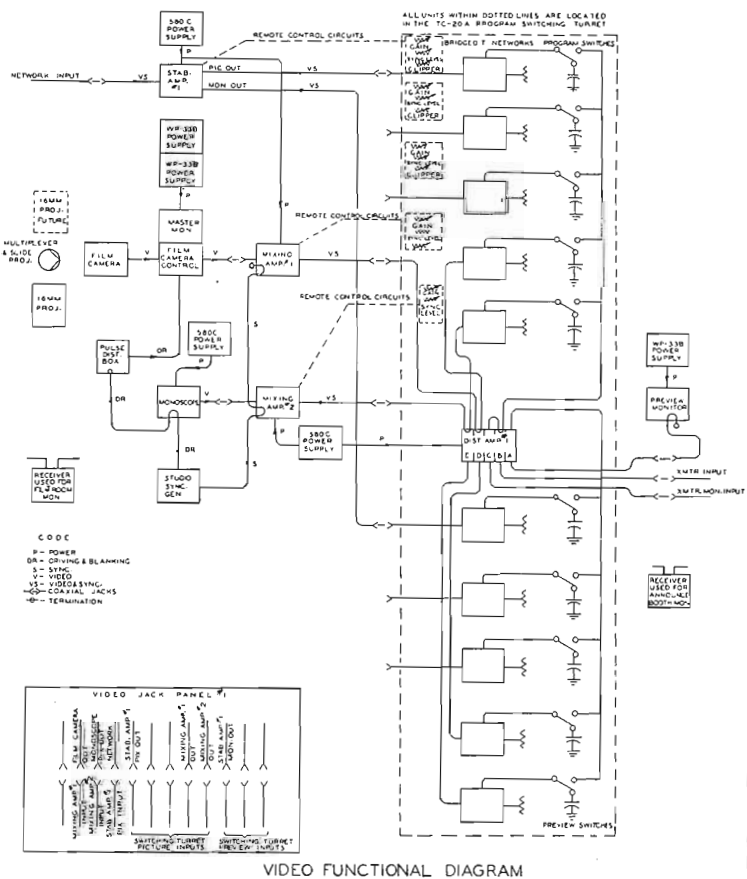

FIG. 9 (above). Panel view of MI-19063 Audio/Video Switching Turret. Capabilities of this system are shown by block diagram below. The system allows previewing and presetting of levels on as many as five audio and five video inputs. Turret is designed for use with standard transmitter consoles.



AUDIO FUNCTIONAL DIAGRAM

buttons are one above the other and can be operated simultaneously with one hand. However, the switches are independent, thus sound and picture can be switched separately if desired.

Audio Circuits

Five audio push buttons are arranged so that any one of them can be operated to feed its signal to the output. The #5 position, intended for a microphone, can be mixed with the signal from #1, #2, #3 and #4, or used alone as desired. Each audio channel includes a 20-step gain control with 2 db steps tapered to infinity. Audio input and output impedances are 600 ohms, balanced. OFF push buttons remove all signals from the output. Audio circuits are electrically interlocked, giving the program circuit priority over audition circuits. Headphones can be used for auditioning the signal by use of a jack supplied for mounting below the desk top. A minimum of -20 dbm audio input level is required.

Video Circuits

Five video circuits are arranged to receive signals from external preamplifiers (one for each program source), and select signals desired for preview and program uses. Video channels #1, #2 and #3 are designed for use with Stabilizing Amplifiers, Type TA-5B (or TA-5C with slight turret modifications). These channels, which require a video input of 0.15 to 2.0 volts peak, are normally used for remotely generated composite signals, but they can be used to mix sync with local signals if necessary.

Channels #4 and #5 are designed for use with mixer amplifiers, Type TA-10A, and can be used for local signals where sync and video are available separately. They require 2.0 volts $\pm 25\%$ video signal, and 4 volts sync signal. The preview and program video circuits are completely isolated. Two identical outputs are obtained from each preamplifier and connected to the turret through 75-ohm coaxial

cable. In the turret, each cable is terminated by a special isolating network. This network permits switching of any of the five video inputs to a Distribution Amplifier mounted in the desk, without the loss of high frequency response. One channel of the five-channel Distribution Amplifier supplies the preview monitor, two channels provide signals for the transmitter and transmitter input monitor, and the remaining two channels provide signals for the preview channels #4 and #5. Mixing of video signals is not possible, but locally generated signals can be faded to black. Five controls are mounted on the front panel to remotely control the gain of five external amplifiers. Eight additional controls, accessible by tilting the panel forward, control sync in the five channels as well as the "picture clipper" controls of stabilizing amplifiers used in channels #1, #2 and #3. Three remaining controls, accessible by removing the turret cover, provide for initial gain adjustment for the three stabilizing amplifiers.

FIG. 10. Transmitter console of WJAC-TV, Johnstown, Pa. Console employs the MI-19063 Audio/Video Switching Turret (center), and TT-5A Transmitter Console with on-air monitor (left). Right-hand units are Film Camera Control and FM Control Turret.

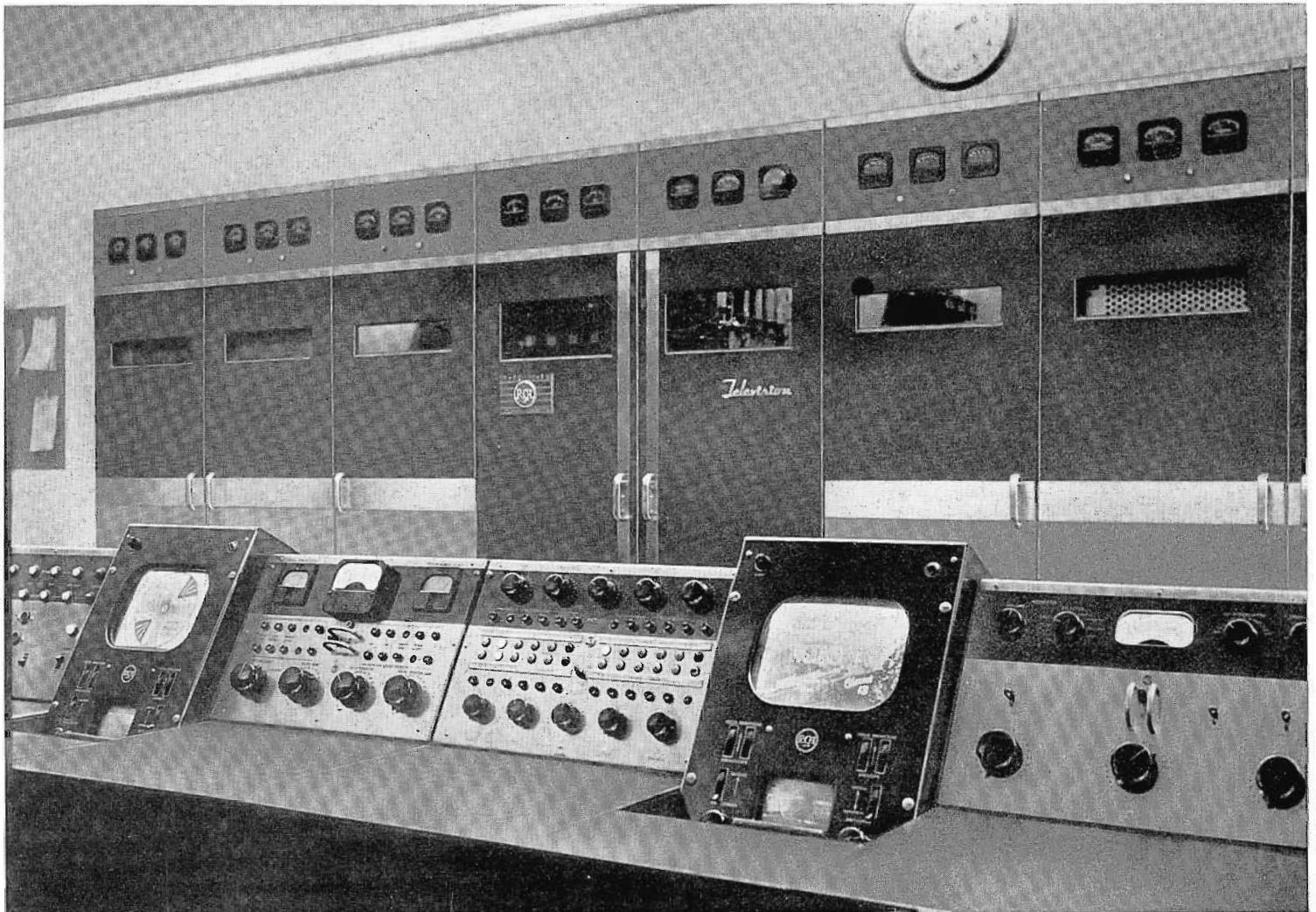

NEW "Unobtrusive" RIBBON-PRESSURE MICROPHONE

by
**HARRY F. OLSON and
JOHN PRESTON**
RCA Laboratories
Princeton, New Jersey

(EDITOR'S NOTE)—*The developmental model microphone pictured and illustrated in this article is a "prototype" and establishes a general pattern for units which will be made available to broadcasters later on a production basis. Many research and design considerations which led to the development of this microphone are described here.*

Ideal For TV and Broadcast Station Uses

Introduction

The general trend of microphones is in the direction of smaller units for the intimate type of sound pickup. One of the first high quality units of this type was the small RCA-KB2C "Bantam" velocity microphone.¹ It was commercialized² more than two years ago. The characteristics of smooth response, high sensitivity and small size of the RCA Bantam velocity microphone have combined to make it an exceedingly popular and successful microphone. At the time that the development work on this microphone was being carried out, consideration was also given to other types of small microphones. It appeared that a small pressure type microphone would be a very useful sound pickup system, particularly for applications where the ambient noise level is not high relative to the useful sound level and where directional discrimination is not required.

In these considerations of a pressure microphone, the type of transducer was evaluated from the standpoints of size, sensitivity, electrical impedance, frequency response, transient and nonlinear distortion and directivity.

¹ Anderson, L. J., and Wigington, L. M., "The Bantam Velocity Microphone." *Audio Engineering*, Vol. 34, No. 1, p. 13, January 1950.

² BROADCAST NEWS, No. 49, p. 4, May 1948.

FIG. 1 (at left). The new microphone is shown mounted on a floor stand. The slim and tubular-shaped unit is small enough so that it does not hide the speaker's or artist's features.

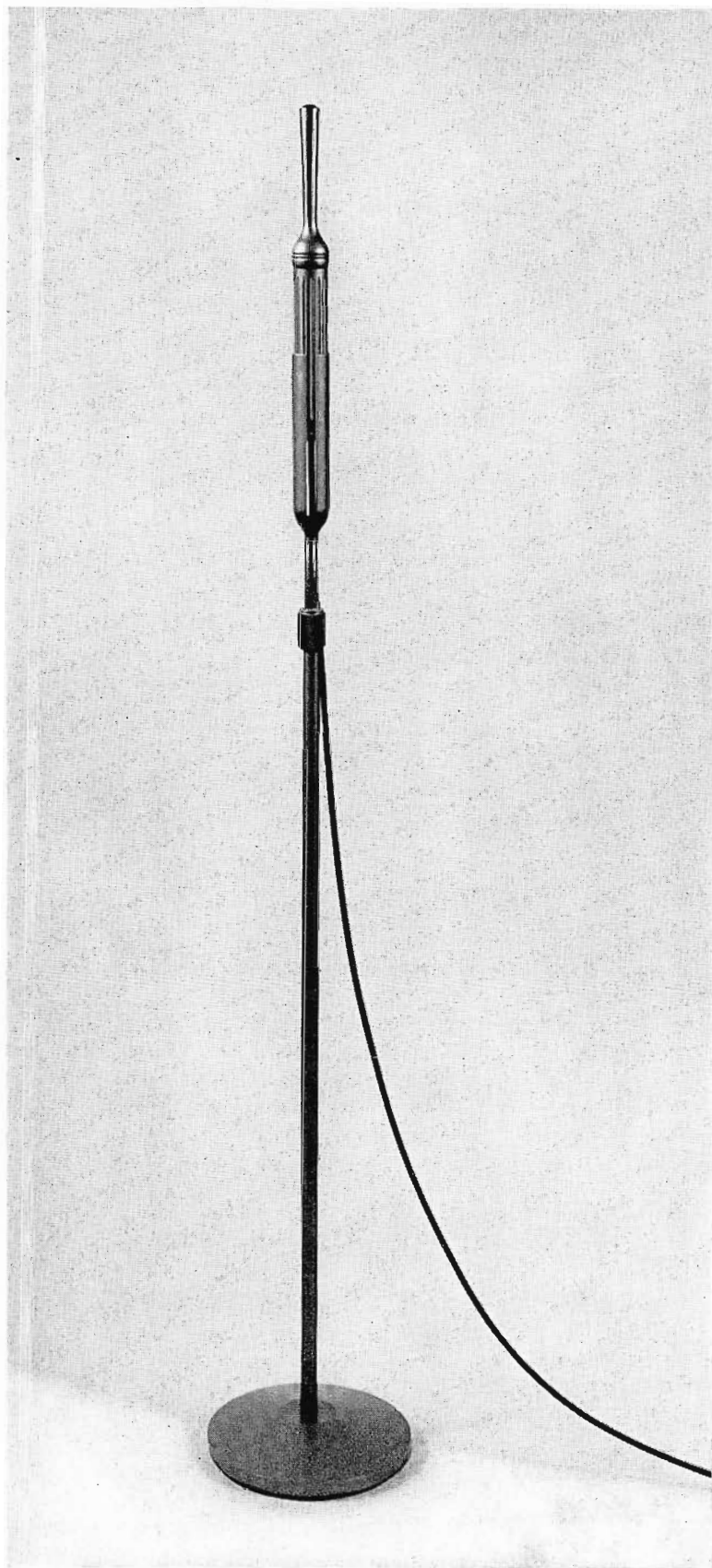

The electrical impedance of a microphone is very important because in the case of certain transducers, it places a limitation upon the distance the signal output may be transmitted over a line without prohibitive attenuation and frequency discrimination. In the case of low impedance transducers, employing magnetic and dynamic transducers, there is no practical limitation upon the length of the lines, providing the transmission distances are confined to those normally used in studios. In the case of high impedance microphones, employing condenser, crystal and electronic transducers, the distances over which signals can be transmitted without considerable attenuation and frequency discrimination are quite small and some expedient must be employed to make it possible to transmit usable signals over the length of lines normally used in studios. If a vacuum tube is used as a part of or directly adjacent to the transducer element, then electronic, condenser and crystal transducers may be used.

Several years ago the mechano-electronic transducer³ was developed. It has been commercialized and is designated as RCA 5734. This is a very small transducer, being 5/16 inch in diameter and 1.3 inches in length. The mechano-electronic transducer makes it possible to build a very small pressure microphone. At the time that the research on the mechano-electronic transducer was in progress, an exceedingly small pressure microphone using this transducer was also developed. It appeared that this was a solution for the small pressure type microphone. However, field tests of the electronic microphone by engineers of broadcasting companies indicated that it was not desirable to locate a vacuum tube at the end of the line or the sound pickup point. They felt that, from an operational standpoint, the nuisance and complexity of running power lines for supplying heater and plate voltages made the vacuum tube system undesirable. As an example, a great majority of microphone failures are due

³ Olson, H. F., "Mechano-Electronic Transducer," *Jour. Acous. Soc. Amer.*, Vol. 19, No. 2, p. 307, March 1947.

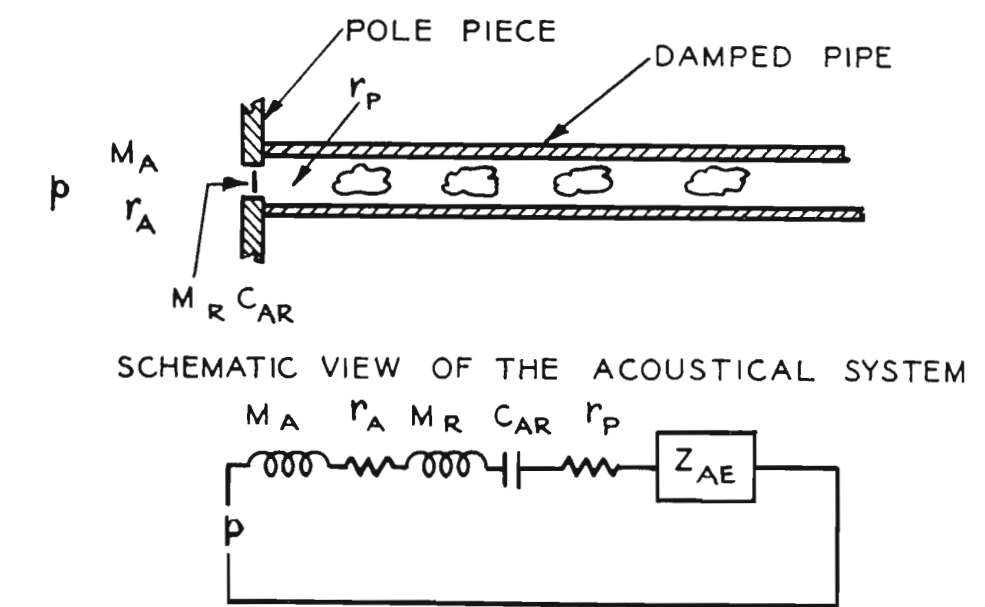

FIG. 2 (above). Acoustical system and circuit of a pressure type ribbon microphone. In the acoustical circuit: p = actuating sound pressure. M_A = inertance of the air load. M_R = inertance of the ribbon. C_{AR} = acoustical capacitance of the ribbon. r_A = acoustical resistance of the air load. r_P = acoustical resistance of the damped pipe. Z_{AE} = acoustical impedance due to the electrical circuit.

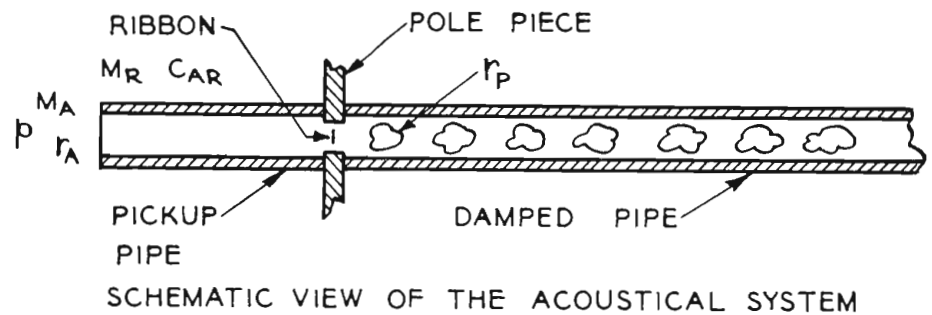

FIG. 3 (above). Acoustical system and network of a pressure type ribbon microphone with a cylindrical pipe used as the sound pickup means. In the acoustical network: p = actuating sound pressure. M_A = inertance of the air load at the open end of the pipe. r_A = acoustical resistance of the air load at the open end of the pipe. The pipe is represented as a quadripole. M_R = inertance of the ribbon. C_{AR} = acoustical capacitance of the ribbon. r_P = acoustical resistance of the pipe. Z_{AE} = acoustical impedance due to the electrical circuit.

to breaks in the cable. Conventional microphones use only two signal leads. This situation would be aggravated by the multiplicity of leads required for the signal, heater and plate power in microphones employing vacuum tubes at the end of the signal line or the sound pickup point.

Quality is another consideration. Broadcast engineers like the smooth response with respect to frequency, the freedom

from nonlinear distortion and faithful response to transients exhibited by ribbon transducers. The low electrical impedance of ribbon transducers makes them absolutely immune to wide variations in temperature and humidity. As a matter of fact, the ribbon transducer can be operated under water⁴ without any additional insulation or protection for the ribbon.

⁴ Olson, Hackley, Morgan and Preston, "Underwater Sound Transducers," *RCA Review*, Vol. 8, No. 4, p. 698, December 1947.

As a result of the background of research, development and field tests described in this introduction, it appeared that the ribbon type transducer would be the logical one for a small pressure type microphone. Furthermore, the response frequency characteristic, output level and electrical impedance characteristic would be comparable to existing ribbon type velocity and unidirectional microphones.

It is the purpose of this paper to describe the development of a small, unobtrusive, pressure type ribbon microphone.

Development Considerations

The vibrating system of ribbon type pressure microphones is shown in Fig. 2. The first consideration is an analysis of the vibrating system.

The velocity of the ribbon, in centimeters per second, is given by

$$\dot{x} = \frac{p}{Az_A} \quad (1)$$

where

p = sound pressure, in dynes per square centimeter,

z_A = acoustical impedance of the vibrating system, in acoustical ohms,

$$z_A = r_A + r_P + j\omega M_R + j\omega M_A + \frac{1}{j\omega C_{AR}} + Z_{AE}$$

where

r_A = acoustical resistance of the air load, in acoustical ohms,

r_P = acoustical resistance of the pipe, in acoustical ohms,

M_A = inertance of the air load, in grams per centimeter to the fourth power,

M_R = inertance of the ribbon, in grams per centimeter to the fourth power,

C_{AR} = acoustical capacitance of the ribbon, centimeter to the fifth power per dyne,

A = area of the ribbon, in square centimeters,

B = flux density, in gaussess,

$$z_{AE} = \frac{Bl^2A}{Z_E}$$

l = length of the conductor, in centimeters, and

Z_E = electrical impedance of the electrical load on the ribbon, in abohms.

The problem is to develop a system with high sensitivity, uniform response, wide frequency range and small size. Studies were made of different structures in an attempt to obtain a system which would satisfy all the requirements. It appeared that a ribbon length of about one inch would be required in order to obtain uniform response to 40 cycles. With the ribbon length established, the next problem was the development of the magnetic structure.

The voltage, in abvolts, generated by the ribbon is given by

$$e = Bl\dot{x} \quad (2)$$

where

B = flux density, in gaussess,

l = length of the ribbon, in centimeters,

\dot{x} = velocity, in centimeters per second.

The electrical resistance, in abohms, of the ribbon is given by

$$r_E = \frac{l}{td} K_r \quad (3)$$

where

t = thickness of the ribbon, in centimeters,

d = width of the ribbon, in centimeters, and

K_r = resistivity, in microhms per centimeter cube.

The power output, in ergs per second, into a matched load is given by

$$P = \frac{r_E e^2}{4} \quad (4)$$

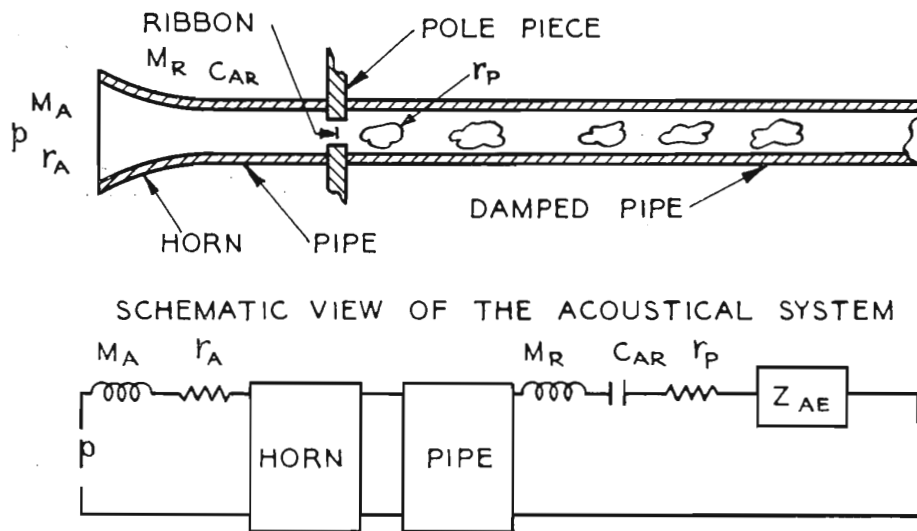
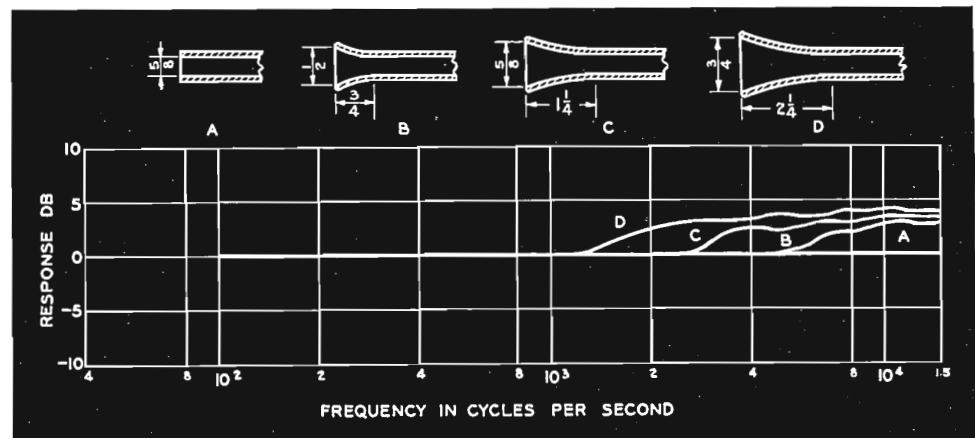

FIG. 4 (above). Acoustical system and network of a pressure type ribbon microphone with a horn coupled to a cylindrical pipe as the sound pickup means. In the acoustical network: p = actuating sound pressure. M_A = inertance of the air load at the open end of the pipe. r_A = acoustical resistance of the air load at the open end of the pipe. The horn and pipe are represented as quadripoles. M_R = inertance of the ribbon. C_{AR} = acoustical capacitance of the ribbon. r_P = acoustical resistance of the pipe. z_{AE} = acoustical impedance due to the electrical circuit.

FIG. 5 (at right). Response frequency characteristics of a cylindrical tube and three horns used as the sound pickup end of a pressure type ribbon microphone.



Using equations 2, 3 and 4

$$P = K_r \frac{l^3 B^2 \dot{x}^2}{4td} \quad (5)$$

K_r , l , t and \dot{x} are fixed under the preliminary assumptions and

$$P = C \frac{B^2}{d} \quad (6)$$

where $C = \text{constant}$.

The problem is to maximize equation 6. This must be done in a certain space and geometrical configuration. The maximum diameter of the unit was fixed at $1\frac{1}{4}$ inches. The maximum weight was fixed at one pound. Under these conditions, the air gap, d , was determined to be .060 inch. The remaining problem was to design a magnet structure which would deliver the maximum flux density, B , to this air gap for the weight which can be allocated the magnet structure.

The diameter of the unit was fixed at $1\frac{1}{4}$ inches. Diffraction effects which govern the discrepancy between the free field sound pressure and the sound pressure on the surface of a cylinder begin at about 5000 cycles for a cylinder of these dimensions. Therefore, a smaller pickup system is required in order to obtain a system free of wide fluctuations in response due to diffraction effects in the frequency range up to 15,000 cycles. It has been shown that a pipe can be coupled to a ribbon unit as shown in Fig. 3, and smooth response frequency characteristics obtained providing the surge acoustical impedance of the pipe is equal to the terminating acoustical impedance. This state of affairs can also be deduced from the acoustical network of the system. Fig. 3.

In a consideration of the response with respect to pickup angle, it appeared desirable to accentuate the response in the extreme high frequency region. An increase in the response in the high frequency region can be obtained by means of a horn as shown in Fig. 4. The response frequency characteristics for a cylindrical tube and three different horns used as the sound pickup end of the pressure type ribbon microphone are shown in Fig. 5. The characteristics of Fig. 5 show that it is possible to accentuate the high frequency response by means of a horn. The magni-

FIG. 6 (at right). This sectional view of the "Unobtrusive" Microphone illustrates the construction employed and shows how various parts are coupled together.

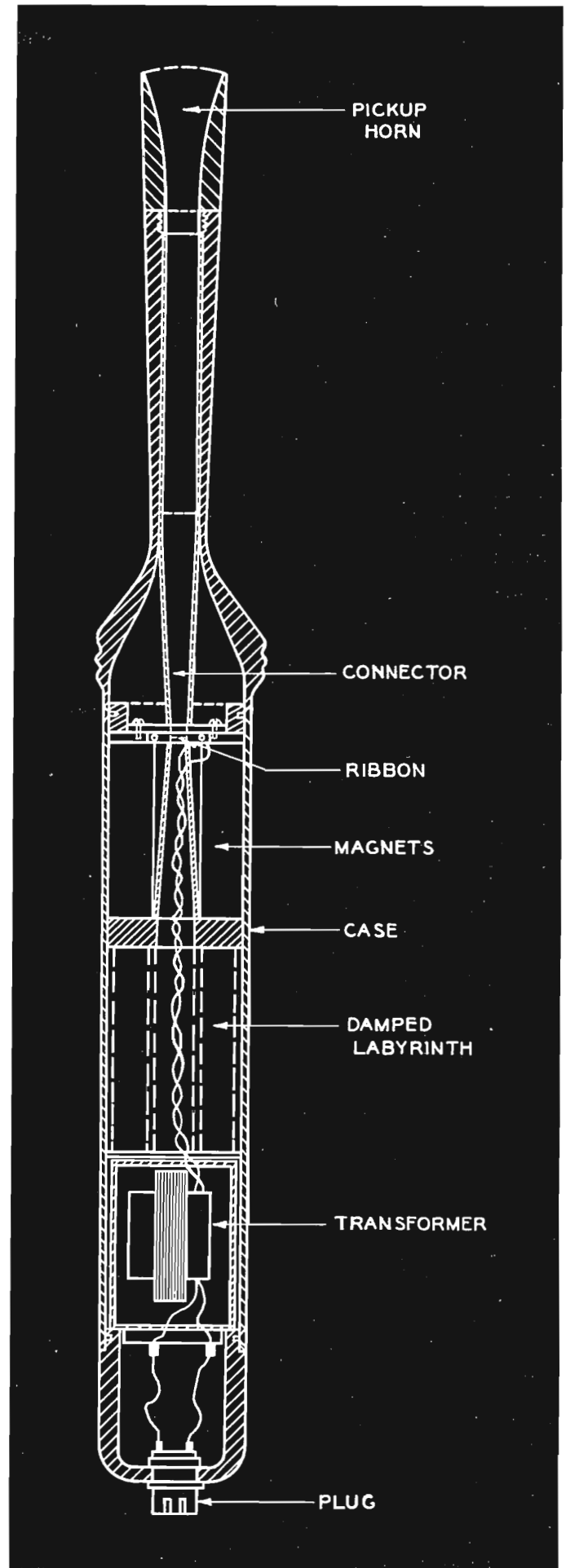

UNOBTRUSIVE MICROPHONE (cont.)

tude and frequency region of the increased response depend upon the dimensions of the horn.

Construction

A detailed sectional view of the unobtrusive pressure ribbon microphone is shown in Fig. 6. A small horn is coupled to a cylindrical tube which in turn is coupled to the front of the ribbon by means of a round to rectangular connector of constant cross-section. The back of the

ribbon is coupled to the damped folded pipe or labyrinth by means of a rectangular to round connector. The ribbon impedance which is practically a pure resistance of .25 ohms is stepped up to a standard line impedance.

A photograph of the microphone as a hand held unit is shown in Fig. 7. A photograph of the microphone mounted in a stand is shown in Fig. 1. The stand is equipped with a cradle for holding the microphone. The cradle is tapped with a standard thread so that it can be attached to a conventional stand. With this arrange-

ment, the microphone can be lifted in and out of the cradle, and thereby separate it from the stand without the use of screws or other semi-permanent fastening means. The cradle increases the usefulness of the microphone when it is used intermittently as a hand held and a stand microphone.

The bottom end of the microphone is also tapped with a standard thread so that the microphone can be mounted semi-permanently on a conventional stand.

Performance

The response frequency characteristic of the microphone for sound incident along the axis is shown in Fig. 8. The response is uniform from 50 to 15,000 cycles. It will be seen that there is some accentuation of response in the high frequency region due to the small pickup horn. The response for sound incident at 90° with respect to the axis of the microphone is also shown in Fig. 8. Under these conditions, the response is uniform throughout the entire response range, the accentuation produced by the horn compensates for the loss by diffraction. It will be noted that the variation in response with angle is very small. This is due to the very small dimension of the pickup tube.

Conclusion

A microphone has been developed for sound reinforcing, broadcast, and television pickup with the following characteristics:

1. Ribbon type pressure microphone.
2. Diameter of body 1¼ inches, overall length 12 inches. Diameter of pickup point 5⁄8 inch.
3. Weight—one pound.
4. Output 110 microvolts per dyne per square centimeter for an output impedance of 250 ohms. The output is comparable to existing microphones.
5. Uniform response from 50 to 15,000 cycles.
6. Nondirectional response.
7. Suitable for hand held or stand use.



FIG. 7 (at left). Closeup view showing the "Unobtrusive" Microphone held in hand.

FIG. 8 (below). Open circuit voltage response frequency characteristic of the new ribbon pressure microphone.

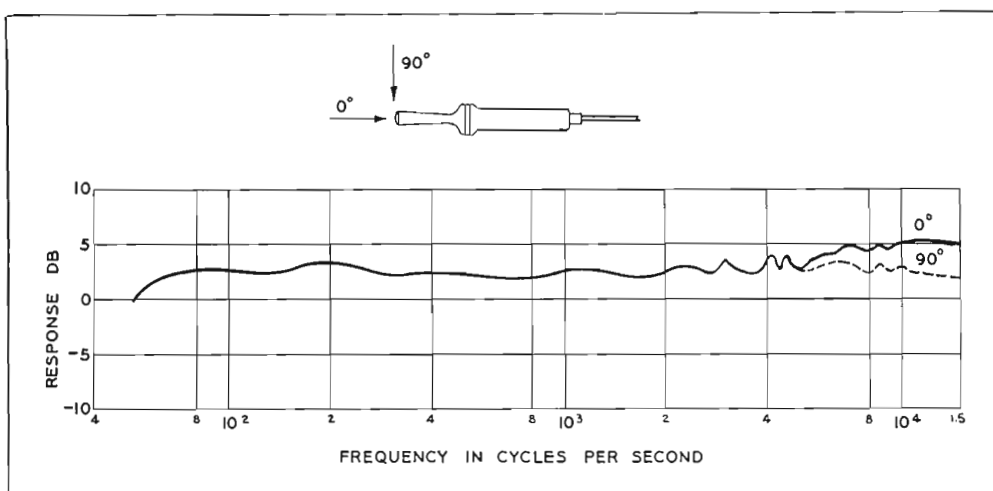

NEW TV UTILITY MONITOR, TM-2A

The Type TM-2A Utility Monitor is designed for use as a television picture monitor in announcers' booths, offices, clients' viewing rooms and control rooms of television stations. It is supplied with a 12½-inch Kinescope in an attractive case. But the TM-2A can also serve as a monitor in the program console, or for rack mounting, in which case it is used less cabinet and with a 10-inch Kinescope. This version may also be used in announce booths, offices, clients' viewing rooms, if special provisions are made.

The new TM-2A Utility Monitor provides the TV Broadcaster with the following features: (1) Useful as program or announce monitor, (2) Easily adapted to portable use, (3) Vertical scanning easily reversed by a switch for use with mirror system of viewing, (4) High impedance video input with provision for looping or terminating the signal, (5) Uses standard RCA receiver deflection, high voltage and low voltage components and circuits—ease of parts replacements and low-cost servicing, (6) Available with case for 12½-inch Kinescope, (7) Adaptors available for either rack mounting or console mounting with 10-inch tube, (8) Contrast, brightness, focus and horizontal and vertical hold controls mounted on panel which can be removed for remote control as in program console use.

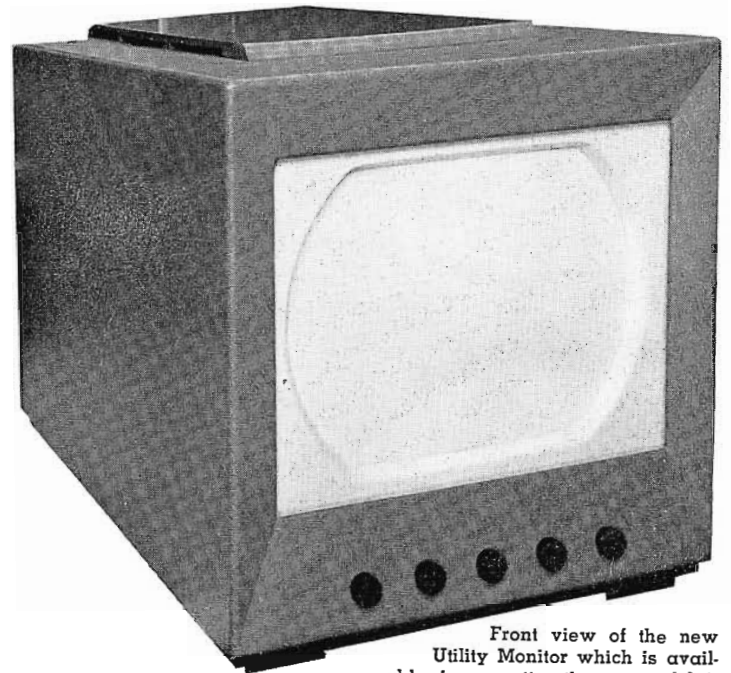

Front view of the new Utility Monitor which is available in an attractive gray fabricoid case with dark umber gray trim.

SPECIFICATIONS

INPUT POWER

Line voltage	117 volts
Line frequency	60 cycles
Line power	180 watts

ELECTRICAL CHARACTERISTICS

Frequency response	6 mc
Signal input range.....	5 volt peak to peak to 4.0 volt peak to peak
Limiting resolution (horizontal).....	500 lines, min.
Second anode voltage.....	10" Kine, 9 kv (approx.) 12½" Kine, 10.5 kv (approx.)

CONTROLS

Remote.....	Contrast, brightness, focus vertical and horizontal hold
Internal.....	Width (2 width controls, shunt and series to give control for "expanded" pix or to see all four corners), height, horizontal and vertical linearity, switch for reversing vertical deflections.

TUBE COMPLEMENT—

1—1B3GT, 2—6SN7GT, 1—6K6GT, 1—6BG6-G, 1—6AL5, 1—5U4G, 1—6W4GT, 2—6AG7, 1—6J5.

MECHANICAL SPECIFICATIONS (Monitor Only)

	12½" Mon.	10" Mon.	12½" Mon. with case
Length	19½" (approx.)	18⅝"	22⅞"
Width	12"	12"	16"
Height	14½"	12⅝"	17½"
Weight	50 lbs. (approx.)	47 lbs. (approx.)	65 lbs. (approx.)
Finish	—	—	Gray fabricoid with dark umber gray trimming

EQUIPMENT FURNISHED

Stock Identification (TM-2A Utility Monitor and Cabinet).....	MI-26298
Includes TM-2A chassis, cabinet and 12 LP 4 Kinescope.	
Stock Identification (TM-2A For Rack Mounting).....	MI-26145
Includes monitor chassis and 10BP4-A Kinescope.	

ACCESSORIES

Rack Mounting Adaptor for MI-26145.....	MI-26524
Accessory Speaker Kit (includes 6" speaker MI-12433, matching transformer, Terminal Board, Variable Potentiometer and knob).....	MI-26533

Description

The deflection circuits are standard receiver circuits using a stable blocking oscillator for the vertical circuit and an a.f.c. circuit for excellent horizontal sync stability.

The high voltage circuit is of the pulse type using 9 kv for the 10-inch Kinescope, and 10.5 kv for the 12½-inch Kinescope. The horizontal deflection circuit is a high efficiency type using damper rectification which supplies boosted plus "B".

The positive low voltage is self-contained which means the monitor can be plugged into any 117 volt, 60 cycle line for immediate operation. The video amplifier is a high-impedance input with provision for looping by several monitors. The frequency response extends to 6 mc fully utilizing the signal available from a closed circuit, such as in the television control room.

The front panel contains five controls: focus, brightness, contrast control, vertical and horizontal hold. The panel may be removed and mounted for use in the program console. A switch for reversing vertical scanning is provided which enables quick change to viewing using a reflected image. The monitor is fused both on the a-c line and the horizontal deflection circuit. The 117 volt, a-c line fuse is mounted in an easily accessible fuse holder. The horizontal deflection protective fuse is mounted on clips inside the high-voltage compartment.

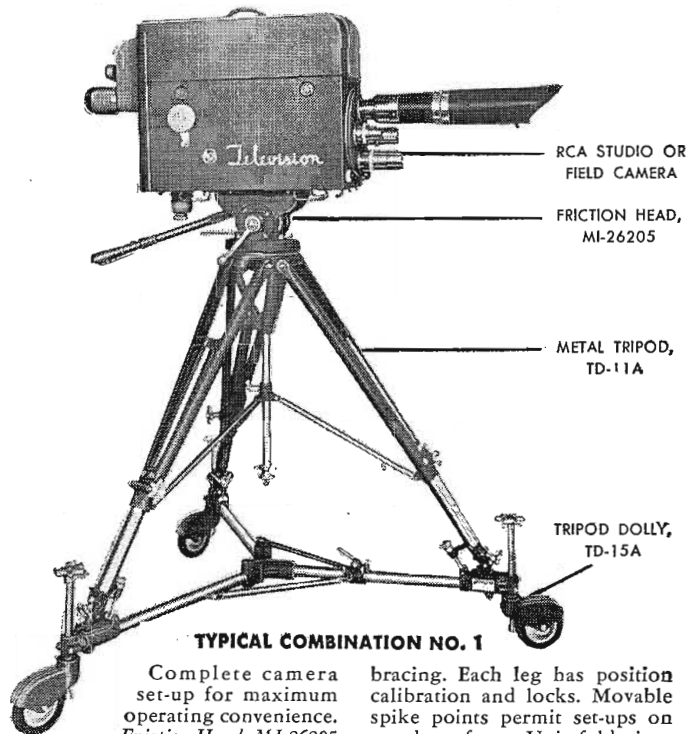

TYPICAL COMBINATION NO. 1

Complete camera set-up for maximum operating convenience. *Friction Head, MI-26205* gives camera 360-degree panning and full tilting action. Has "degree-indicator" scales and locking handles. *All-Metal Tripod, TD-11A* uses individual tie rods and center post for sturdy

bracing. Each leg has position calibration and locks. Movable spike points permit set-ups on rough surfaces. Unit folds into compact, self-locking package. *Tripod Dolly, TD-15A* takes up a circular area only 57" diameter. Wheel stops for fixed positions. Folds and carries in a compact package.

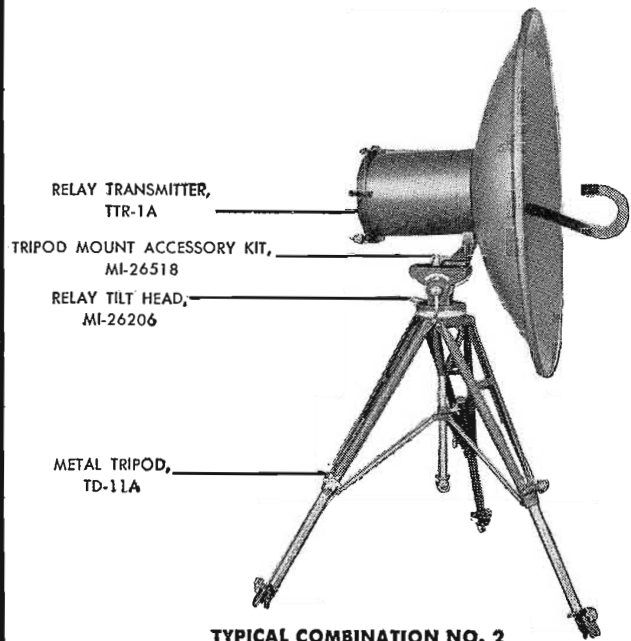

TYPICAL COMBINATION NO. 2

A complete vhf relay transmitter for difficult terrain and long distances, where radio relay is more practical than coaxial cable. *Tripod Mount Accessory Kit, MI-26518* provides means for mounting relay equipment to tripod. Includes mounting plate, saddle, and bolts.

Relay Tilt Head MI-26206 provides wide adjustment angles for vertical tilt and horizontal rotation. Sealed bearings for all-weather service. Accurately calibrated. Individual locking handles. *Metal Tripod TD-11A* same as Combination No. 1.

Dollies, booms, stands,

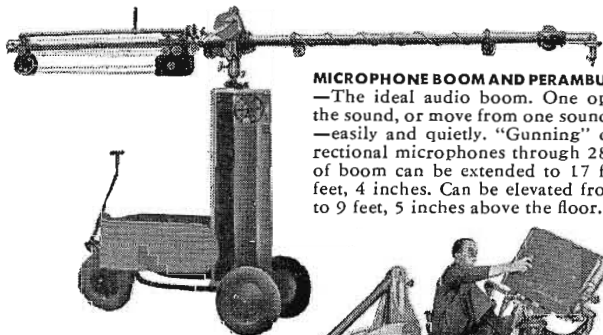

MICROPHONE BOOM AND PERAMBULATOR, MI-26574
—The ideal audio boom. One operator can follow the sound, or move from one sound source to another—easily and quietly. "Gunning" device revolves directional microphones through 280 degrees. Radius of boom can be extended to 17 feet; retracted to 7 feet, 4 inches. Can be elevated from 6 feet, 5 inches to 9 feet, 5 inches above the floor.

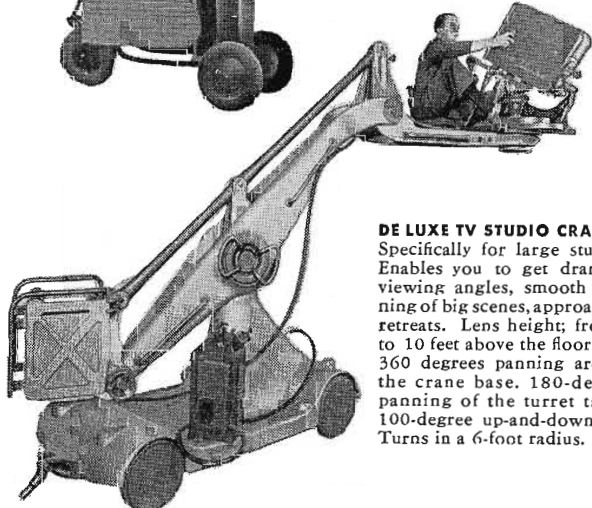

DE LUXE TV STUDIO CRANE—Specifically for large studios. Enables you to get dramatic viewing angles, smooth panning of big scenes, approaches, retreats. Lens height; from 2 to 10 feet above the floor. Full 360 degrees panning around the crane base. 180-degree panning of the turret table. 100-degree up-and-down lift. Turns in a 6-foot radius.

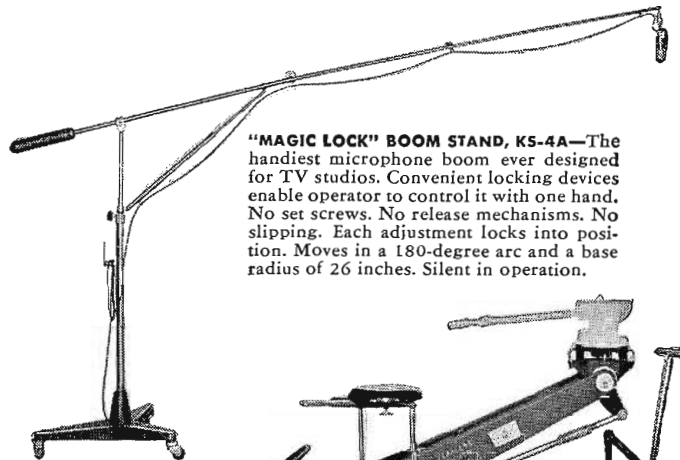

"MAGIC LOCK" BOOM STAND, KS-4A—The handiest microphone boom ever designed for TV studios. Convenient locking devices enable operator to control it with one hand. No set screws. No release mechanisms. No slipping. Each adjustment locks into position. Moves in a 180-degree arc and a base radius of 26 inches. Silent in operation.

STUDIO CAMERA DOLLY, TD-5A—Similar to the dollies used in film studios—but both front and rear wheels turn to the side. Entire unit can be moved sideways. Stops lock the dolly in a fixed position. Camera crane boom can be elevated from 23 inches to 74 inches above the floor.

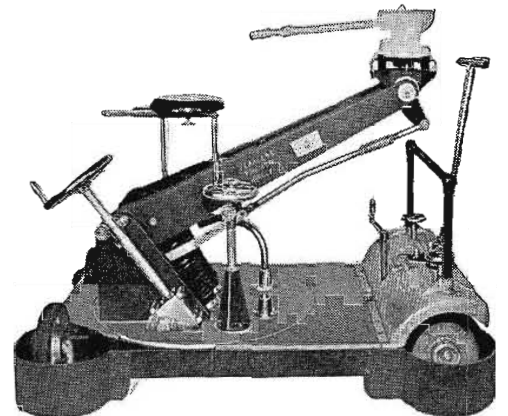

RCA STUDIO OR
FIELD CAMERA

FRICITION HEAD,
MI-26205
LO-HAT,
MI-26190-1

METAL TRIPOD,
TD-21A

METAL DOLLY,
TD-25A

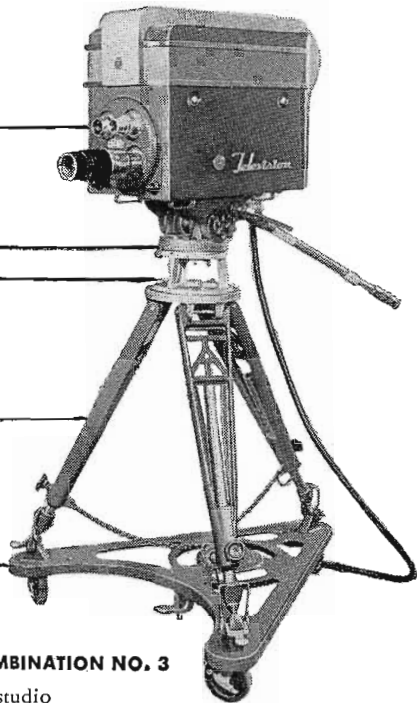

TYPICAL COMBINATION NO. 3

Another camera set-up for studio and mobile work. Handles RCA Studio Camera or Field Camera. *Friction Head, MI-26205* same as used in Combination No. 1. *Lo-Hat, MI-26190-1* provides greater freedom and height for camera action. *Metal Tripod TD-21A* for fixed or portable set-ups. Cast

aluminum and stainless steel construction. Legs adjustable up to 21 inches. Dual feet; pointed for field work and flanged for fixed service. *Metal Dolly TD-25A*. Non-swiveling. Foot-controls for parallel wheel alignment. Individual wheel and tripod locks.

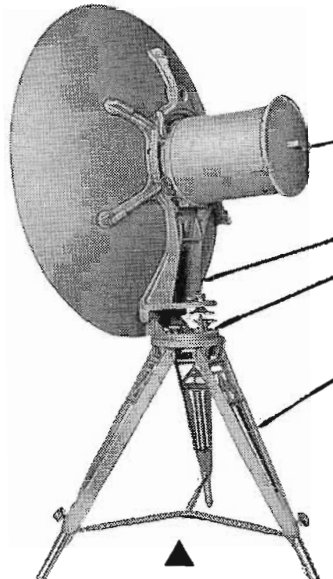

RELAY RECEIVER,
TRR-1A

REFLECTOR AND
PARAPET MOUNT,
MI-26187

METAL TRIPOD,
TD-21A

TYPICAL COMBINATION NO. 4

A complete relay pick-up receiving system. Relay receiver and parabola fasten to tripod through Reflector and Parapet Mount, MI-26187. *Metal Tripod, TD-21A* is set up for rough surfaces.

Field Camera and Friction Head, MI-26205, can be mounted on *High Hat MI-26190-2* for wall or parapet use. Complete assembly is attached to *Parapet Clamp Support MI-26189*.

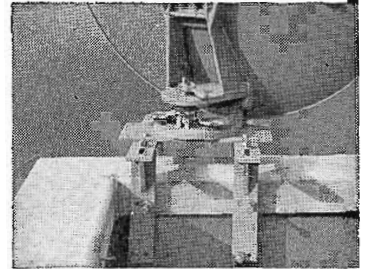

▲ Here, Reflector and Parapet Mount MI-26187 fasten to Clamp Support, MI-26189—which mounts on top of wall. Relay reflector may also be permanently mounted in wall openings by means of "Gimbal" Antenna Ring Mount, MI-26207 (not illustrated).

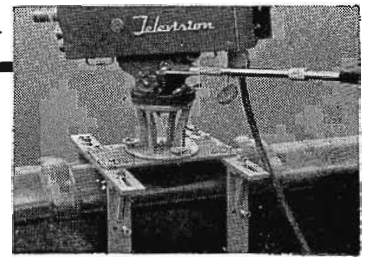

mounts, accessories...

for every TV set-up

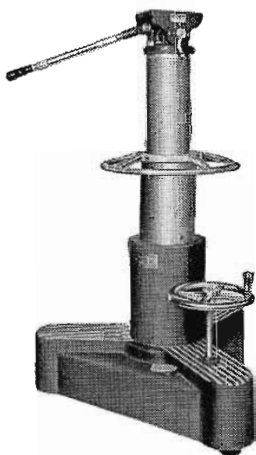

STUDIO CAMERA PEDESTAL, TD-1A—Television's favorite pedestal for studio and other indoor operations. Moves freely, quietly. Crank handle raises and lowers camera to any height between 40 inches and five feet above the floor. Moves in any direction—or about a point. Panning and tilting provided by Friction Head MI-26205.

PICTURED on these pages are typical units and combinations from the most complete line of television accessories in the industry—application-engineered to meet every pick-up situation called for in your TV operations.

This line of mechanical accessories enables you to select just the right combination for your station operation. It includes every device needed for providing universal camera action in the studio and the field. It provides additional flexibility for maneuvering and covering shots from any angle.

RCA TV accessories are stoutly built to withstand the tough wear and tear encountered in field and studio operations. Yet each unit is a model of mechanical simplicity—easy to transport, easy to set up, easy to adjust, and easy to handle.

RCA TV accessories like these are used today in nearly every television station in the country. For complete information on the entire line, call your RCA Broadcast Sales Engineer. Or write Dept. 19JD, RCA Engineering Products, Camden, New Jersey.



TELEVISION BROADCAST EQUIPMENT
RADIO CORPORATION of AMERICA
ENGINEERING PRODUCTS DEPARTMENT, CAMDEN, N.J.

In Canada: RCA VICTOR Company Limited, Montreal



NAB ENGINEERING CONFERENCE

STEVENS HOTEL, CHICAGO

**APRIL 12-15
1950**



The picture above was taken at the opening session of the recent NAB Engineering Conference. More than four hundred station, consulting and industry engineers registered for this conference. Part of them are shown in this group picture (some hadn't arrived yet when it was taken); others are shown in the informal photos on the following pages; still others belong

to that camera-shy group we never seem able to catch.

Why do we publish these pictures. There are several reasons. For one thing to recall pleasantly to those who were there the things they participated in. For another, to give those who were not there an idea of what they missed. But there is still another reason—and that is because we

would like to help promote the idea of station engineering as a profession—a profession which we feel is only just beginning to achieve the status it deserves. The annual NAB Engineering Conferences—of which this year's was the fourth—have done much to establish the position of engineers in the industry. In addition they provide a place where station engineers can

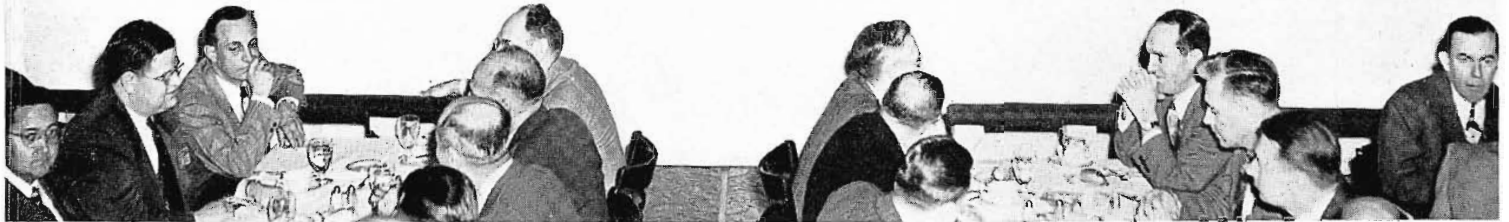

Head table at the Thursday Luncheon Session. Speakers were Judge Justin Miller, President of NAB (at left of rostrum) and Raymond F. Guy, President of the Institute of Radio Engineers (second to right of rostrum). They were introduced by Neil McCnoughten, Director of the NAB Department of Engineering (at right of rostrum) under whose capable direction the Engineering Conference was planned and carried out.

become acquainted with each other, exchange information, and discuss together their mutual problems. The value of these things is not measured in the number or titles of the papers delivered. It is meas-



Capt. W. C. Eddy, Manager of Television Associates (left) and W. W. Watts, Vice President in charge of RCA's Engineering Products Department, discussing the RCA television studio equipment setup which, following the convention was shipped to Stephens College, Columbia, Missouri, where it will become a permanent part of the curricula facilities.

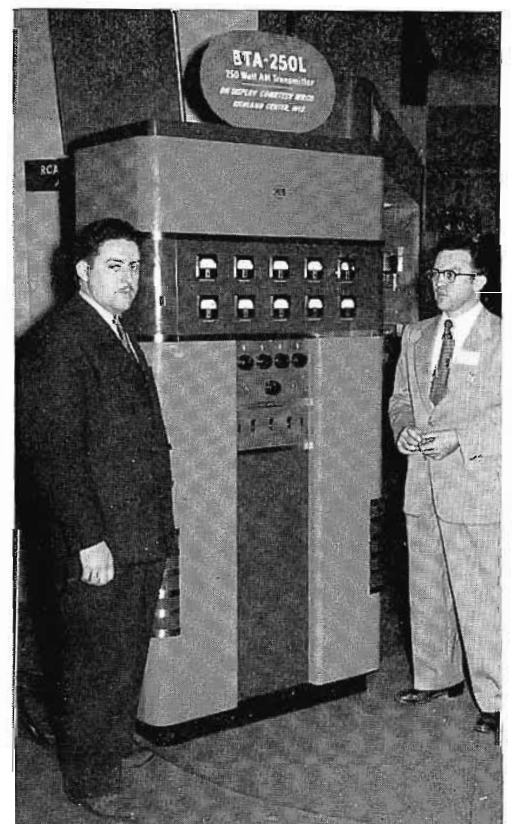

Thomas R. Kelley, General Manager of WRCO, Rockland Center, Wisconsin, admiring the RCA 250-L Transmitter which he purchased for WRCO.



George M. Whitney of WGRY, Gary, Indiana (center), talking equipment problems with J. L. Nickels, RCA Representative in Chicago area and E. C. Tracy, Manager of RCA Broadcast Field Sales Group.



Head table at the Friday Luncheon Session. Speaker, on this occasion, was G. Emerson Markham, until recently Director of the NAB Department of Television (second to right of rostrum). He was introduced by A. James Ebel, Chief Engineer of WMBD, Peoria (right of rostrum), who is chairman of the NAB Engineering Executive Committee. The committee is composed of representatives of member stations.

ured, rather, in the confidence, the knowledge, the stature which the station engineer gains by attending. The Conferences are a good thing for all—they should have the full support of the industry.



An opportunity to discuss equipment problems with factory representatives is one of the advantages of the NAB get-together. Here John Palmquist, RCA Representative for Dallas area and W. B. (Walt) Varnum, RCA Representative for Kansas City area, are talking things over with Duane W. Hoisington, General Manager of KAYS, Hays, Kansas.



An opportunity to "push-the-buttons" yourself was presented by this Video Relay Switching display. W. O. Hadlock demonstrates the operation.

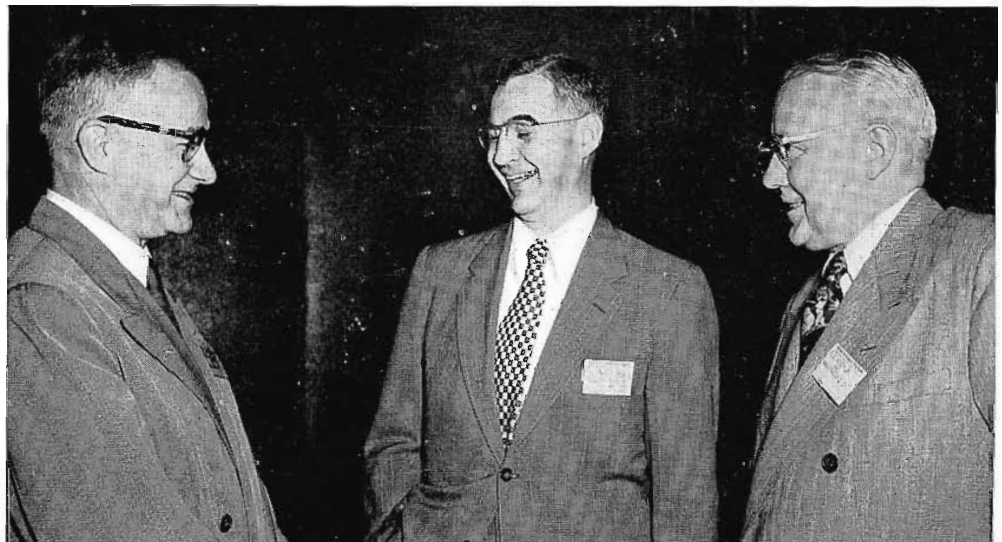

Judge Justin Miller, President of NAB; John P. Taylor, Editor of Broadcast News; and C. E. Arney, Secretary of NAB (and directing genius of the Convention), at the Speaker's Reception on Thursday.



RCA SHOWS NEW EQUIPMENT AT NAB CONVENTION

One of the greatest appeals of the NAB for station engineers is the opportunity to learn firsthand about all kinds of equipment—to examine it inside and out, to talk to the engineers who designed it—and to talk to other station engineers about it. Station managers, too, like the “push the buttons yourself” approach.

With this thought in mind we have, for many years, planned our NAB shows to be “working” type exhibits—i.e., featuring equipment (operating, if possible) rather than decoration and display. In the im-

mediate postwar years everything in equipment was new—and we tried to show it all. This year we decided to place the emphasis on new items. Most of the stations, we knew, had their main installations pretty well in shape. We felt that their interest, therefore, would be less in transmitters and the like, and more in accessories and extra items of the more or less expendable type, with special interest, no doubt, in new gadgets which would make for better programming, more efficient operation, or (praise be) more income.

For those of you who were not fortunate enough to see this exhibit, the following is a brief listing of the major new items shown. Some of these are illustrated more fully elsewhere in this issue, others will be described in the next issue. (Those who can't wait can get more details from their RCA Sales Engineer.)

NEW TAPE RECORDER (Type RT-11A) is designed to meet the very highest professional standards. It features synchronous drive, quick start and stop by push-button

LEFT, ABOVE: Entrance to the RCA display space at the NAB Convention. At the extreme left is a large-size replica of RCA's 400-page catalog of broadcast equipment. At the right is a flasher-illuminated map showing the type of camera, studio, transmitting and antenna equipment used by every one of the TV stations on the air today.

LEFT, BELOW: Looking down the length of the RCA display space. As in other years this space was largely devoted to “working” type exhibits—with special emphasis this year on new equipment items.

BELOW: W. W. Watts, Vice President in Charge of RCA's Engineering Products Department, and T. A. Smith, General Sales Manager of the Department, admiring the RCA-5831 Super-Power Beam Triode which was a feature of the RCA exhibit. This new tube, which is capable of 500 kilowatts of continuous output, and which has been tested at one million watts input, is expected to open the way to new developments in the high-power field which were hitherto economically unfeasible or impractical because of the banks of tubes and the size of associated equipment required. (See Broadcast News, Vol. No. 58, March-April, 1950, Pg. 8.)





NEW EQUIPMENT

control and optional remote control (see further details on Pg. 44).

ANTI-NOISE MICROPHONE (Type KB-3A) eliminates acoustic feedback, pickup of side comments during interviews, etc., while retaining high fidelity of ribbon-type microphone. (See article on Pg. 4.)

UNOBTRUSIVE MICROPHONE is a ribbon-type microphone built into a very slim case with a narrow top section. It does not hide the speaker's face, provides high-fidelity reproduction, does not require a preamplifier in the microphone case (as do condenser types).

LIGHT-WEIGHT PICKUP (MI-11885) is designed for reproduction of 45 and 33 $\frac{1}{3}$ fine-groove records on existing series 70 type turntables, but may also be used with other turntables of broadcast type.

FLYING SPOT CAMERA provides high-quality still pictures from 35mm, 2 x 2 inch transparencies. Spot-source is a five inch cathode ray tube. Two six-slide holders are designed to provide accurate registry. Fades, superimpositions and lap dissolves are possible (see further details on Pg. 40).

SPECIAL VIDEO EFFECTS of many different types are made possible by an attachment for the flying spot scanner (see above). Two video signals may be mixed, faded or wiped in any desired combination (see illustrations on Pg. 41).

PORTABLE FILM PROJECTOR may be used to televise film at remote locations by focusing directly on the mosaic of a standard field camera. This arrangement will allow commercials to be telecast directly from ball parks and other remote pickup points. (See Pg. 45.)



LEFT, TOP: RCA Field TV Units on three of the new folding desk units (in the center). This equipment was used to demonstrate the operation of the Flying Spot-Video Effects Equipment in the console-type unit at the right of the picture.

LEFT, CENTER: W. W. Watts (seated), Vice President in Charge of the RCA Engineering Products Department, discussing the new video effects equipment with V. E. Trouant (center), Manager of the Broadcast Engineering Section, and T. A. Smith, General Sales Manager of the Department.



LEFT, BOTTOM: The new Flying Spot Camera and Video Effects Equipment is built into this convenient operator's console. Intended to be located in the control room, somewhat like a transcription turntable (which it resembles in size and shape). The controls provide for mixing, wiping, and lap dissolving of two pictures, one of which may be from the scanner itself, while the other (or both) may be from a studio, remote or film pickup.

ITEMS AT NAB

UTILITY MONITOR (Type TM-2A) is a high-quality extension monitor suitable for use in offices and viewing rooms, as an announcer's monitor, or as an auxiliary monitor in control rooms. (See details on Pg. 63.)

GENLOCK (Type TG-45) makes it easy for stations to switch, lap-dissolve, and superimpose video remote programs with studio programs. This unit was described in detail in the last issue of *BROADCAST NEWS*.

FIELD FADER CONTROL (MI-26286) is a small camera switching unit in which fading facilities are provided. Intended for use with RCA TV Field Equipment it provides for fading between cameras (a function which was not provided for in the original TS-30A Switching Unit—although it is incorporated in the new design).

FOLDING DESK UNIT especially designed for field use (but also suitable for some studio applications) holds two standard RCA TV Field Units. Several desk units may be used together when more cameras are used (see Pg. 38).

NEW TRIPOD AND HEAD (Type TD-11A Tripod and MI-26205-A Friction Head) have a number of interesting features not found in older models.

INDUSTRIAL TV EQUIPMENT, very small in size and of extremely simplified design, is presently suitable for industrial, educational and other applications not requiring the better resolution of standard image orthicon cameras. (See Pg. 42.)

RIGHT, TOP: Dave Newborg, RCA Field Representative in Cleveland area, demonstrates the new Type RT-11A Tape Recorder to Mr. C. E. Denny and Mr. J. A. Young of WERC, Erie, Pa. Push-button control (remote, if desired), quick start and stop, near absolute timing, and automatic stopping in case of tape breakage are outstanding features.

RIGHT, CENTER: Charles B. Brown of Masterson, Reddy & Nelson, H. C. Elwes, Field Coordinator for RCA Engineering Products Department, and E. J. Frost, RCA Representative in Los Angeles, discuss the Portable TV Film Projector, shown here with standard RCA TK-30A Field Camera.

RIGHT, BOTTOM: Latest models of RCA's complete line of field intensity meters were on display. In this picture E. S. Clammer, of the RCA Broadcast Transmitter Section, is pointing out features of the WX-1A Meter to E. Gailans, of the F.C.C.





CONVENIENT OPERATION of the Flying Spot Scanner-Video Effects Unit is demonstrated by John H. Roe, Manager of RCA Television System Engineering Group, at the NAB Convention. The console unit may be conveniently placed near the studio control equipment, as shown here.

FLYING SPOT CAMERA FOR TRANSPARENCIES

The RCA Flying Spot Camera is especially designed to answer the broadcaster's need for equipment capable of producing high-quality pictures from photographic transparencies. With this equipment it is possible to fade, superimpose or lap dissolve pictures obtained from 35mm, 2 x 2 inch transparencies.

An important feature of this equipment is the fact that it is less expensive to operate than the present film cameras which are ordinarily used for slide transmissions. Where test patterns or stills are used for long periods this saving may be considerable. It is also much more convenient to operate—and, in most cases, more flexible than present equipment.

The spot source is a five-inch cathode ray tube, employing a very short persistence phosphor. The tube is mounted vertically, with its face up. The spot is reflected horizontally by a mirror and then is split by two mirrors in a V so that two transparencies can be scanned simultaneously.

All the video, deflection, blanking, bias and high voltage circuits are located within the 25 x 25 inch frame. An externally mounted WP-33B Power Supply is required. The top section includes the optical systems, photocells, preamplifiers for two separate picture scanning systems and the normal operating controls. The secondary controls are located at the front just below the top.

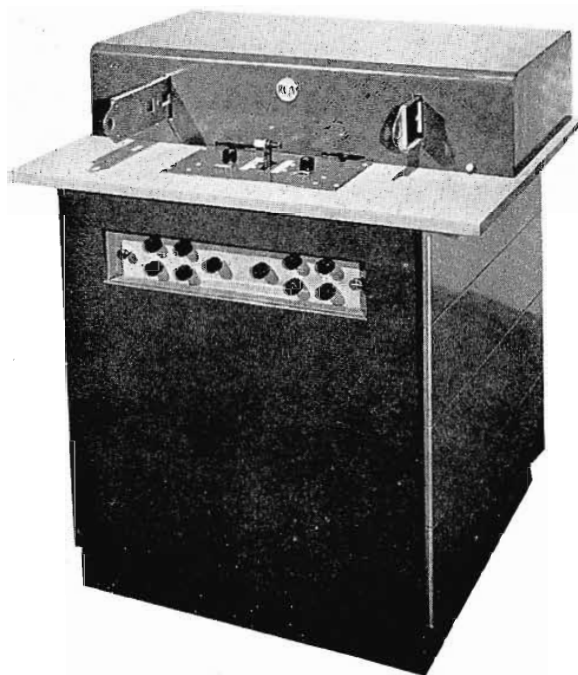

CONSOLE TYPE CABINET houses the complete Flying Spot Scanner and the variable masking arrangement used in obtaining video effects. (Additional circuits of the video effects equipment are mounted in a rack unit which may be located some distance away.) Two slide holders (each holding six slides) may be seen projecting from the upper case at convenient table level. Between them are located fading and lap dissolve controls. The operator can handle all operations from a comfortable sitting position.



SPECIAL SLIDE HOLDERS have an arrangement by which slides may be accurately positioned before slide holder is inserted. In this picture, Norman Bean, RCA television engineer is showing one of these slide holders to John G. Leitch, Vice President in Charge of Engineering, WCAU, Inc. The special variable area masking device used in generating the signal for special video effects has been inserted in the position normally occupied by the right-hand slide holder.

AND A WIDE RANGE OF UNUSUAL VIDEO EFFECTS

Another important use for the Flying Spot Scanner shown on the opposite page is the generation of signals for special video effects. This type of operation makes it possible to insert a part of a picture within another and to control the shape of the insert opening so the inserted picture can be wiped out, mixed, or faded.

These effects are obtained by inserting in the Flying Spot Scanner an opaque mask—which may be of either fixed or variable area. The boundaries of the mask determine the boundary between the two pictures selected for transmission. The mask may be moved or changed in shape, with a corresponding movement or change in shape of the boundary between the two video signals.

This arrangement offers almost unlimited combinations for mixing, fading or wiping. One signal may be wiped off with another following on, in any direction. Either signal can be faded to a third signal independently of the other one, and so on. Some of these effects are shown in the pictures on this page. Many others will suggest themselves.

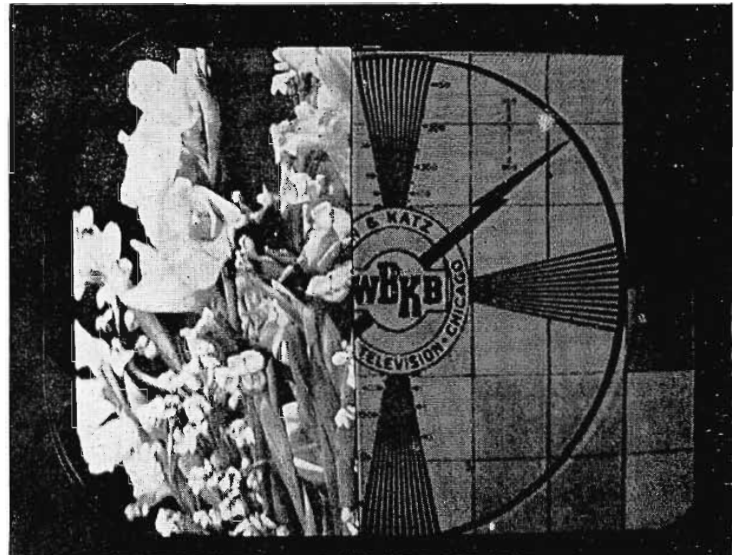

HORIZONTAL OR VERTICAL WIPES are accomplished with the greatest of ease. The wiping may be done in either direction, at any speed.

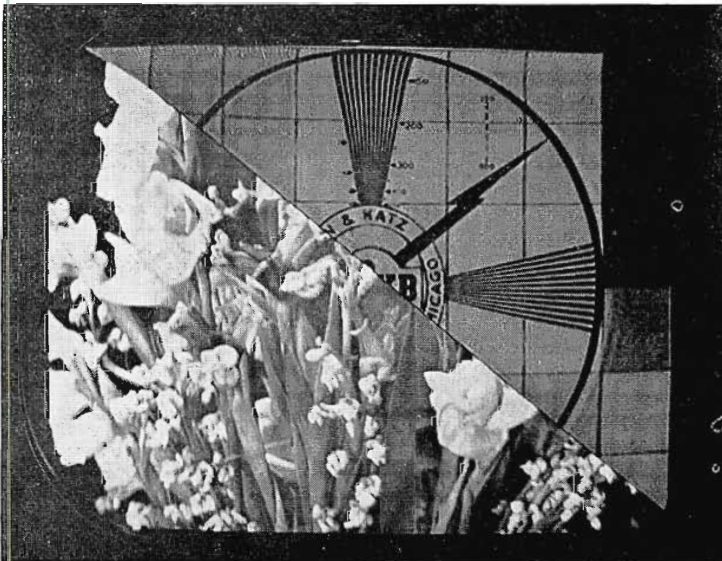

ANGLE WIPES, from lower left to top right, or vice versa, may be applied to any two picture signals, from any source.

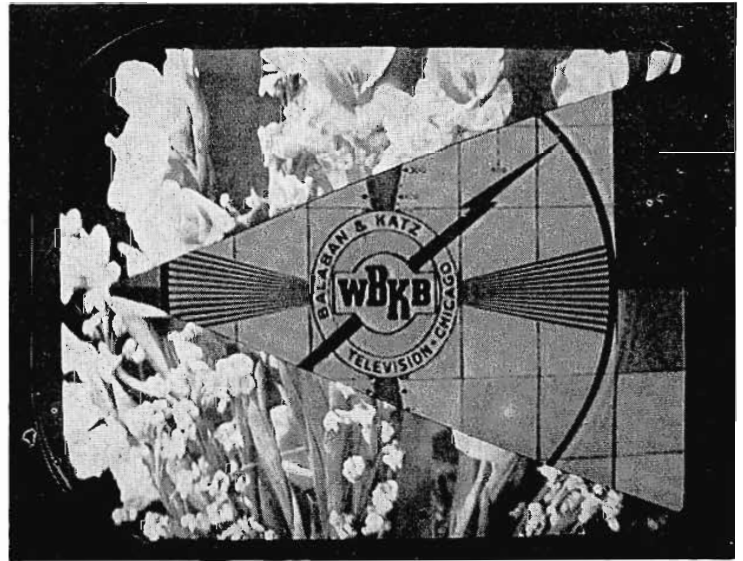

POINTED WIPES in which a wedged shaped area of one picture moves into—or out of—the area of another picture, are possible.

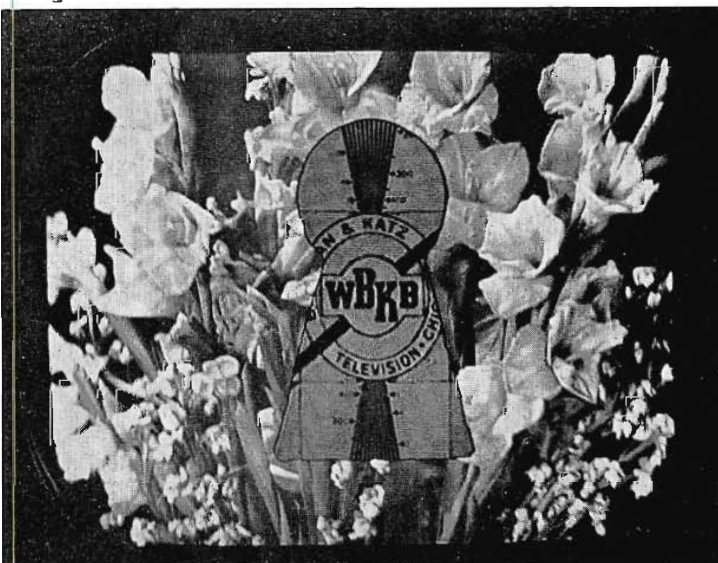

STRANGE SHAPED INSERTS, of any kind that the imagination can conceive, can be obtained by making up a mask of the shape desired.

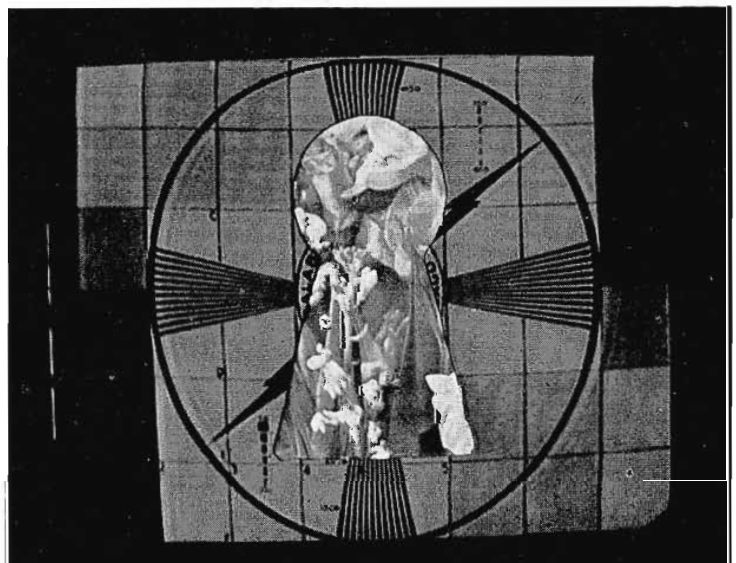

REVERSAL of the two pictures is accomplished by simple switching. Pictures from studio, remotes, film camera, etc., can be used.



VIDECON CAMERA operation is demonstrated by Norman Bean (right) RCA television engineer, for a group of Young & Rubicam executives, including R. E. Buchanan, Roland Gillet and Edward Leftwich.

VIDECON EQUIPMENT IDEAL FOR INDUSTRIAL TELEVISION

One of the most interesting new items shown at the NAB Convention was the Type ITV-1 Industrial Television Equipment. This equipment, built around the pint-sized Videcon pickup tube, is far smaller, and considerably less expensive, than standard image orthicon cameras. Its resolution is less than that of the image orthicon and it has some tendency to "stick" so that it is not presently suitable for broadcast purposes. However, the picture delivered is of surprisingly good quality and certainly is suitable for most of the so-called industrial applications. It should be particularly useful in observing processes which are relatively inaccessible or which, because of the danger, cannot be approached closely. It is also being tried out for applications such as television rehearsals (to save on time and cost of big camera operation) and the production of television movies (where it may be used to monitor the scenes picked up by several film cameras—and thereby give the director an opportunity to direct the camera operations more closely).

EDUCATIONAL APPLICATIONS of the Videcon equipment are suggested by this picture, also taken at the NAB Convention. A Videcon Camera is mounted on the light microscope and controls focused to pick up the magnified image of the bacteria on the microscope slide. A standard 16-inch receiver (top left) connected as an extension monitor, reproduces the picture large size—so that many people can see the enlarged image. Interested observers are M. C. Banca, RCA; Mrs. Everett Bliss, KCIM; Paul Clark, RCA; and Mr. Everett Bliss, KCIM.

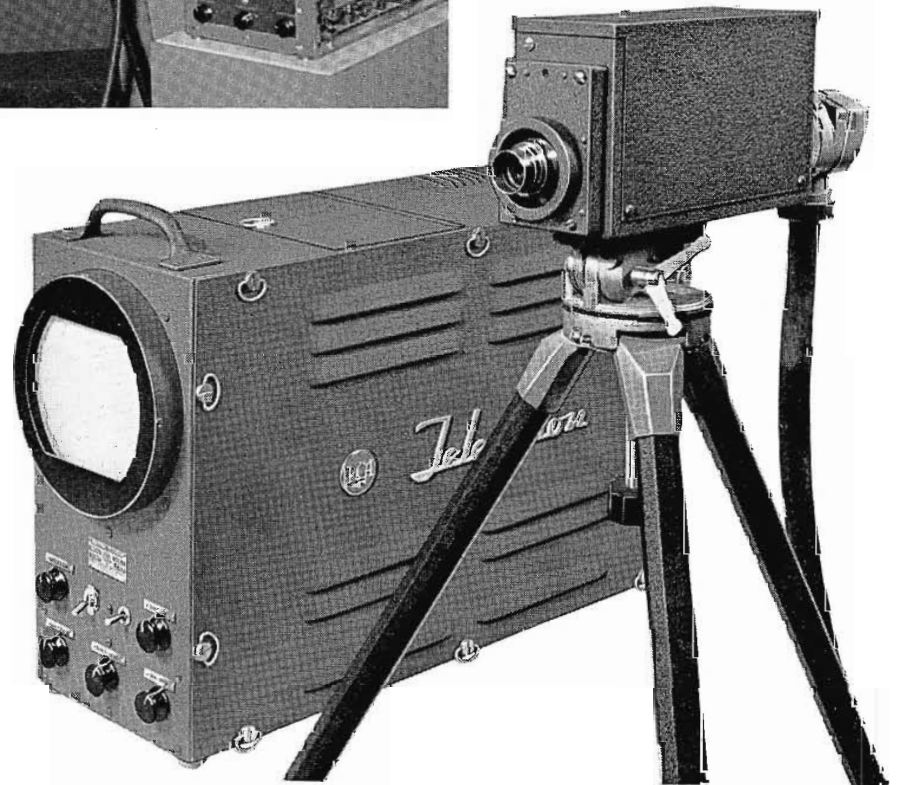

VIDECON EQUIPMENT is complete in these two units. The camera proper is only a little larger than a 16mm movie camera. The control unit which contains the sync generator, deflecting circuits, video amplifiers, controls and monitor kinescope is the same size as one of RCA's standard field units.



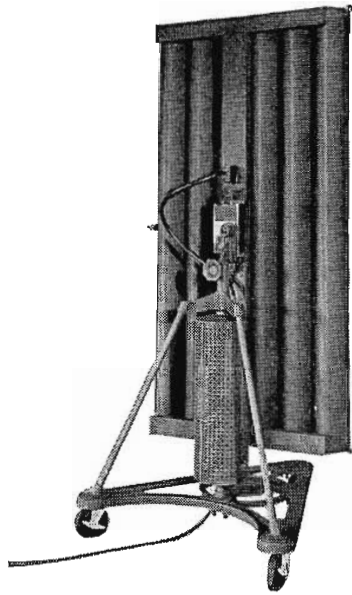

LIGHTING EQUIPMENT of all kinds was on display in the RCA booth at the NAB Convention. The Hi-Intensity Dolly Light, shown above, features a special built-in ballast.

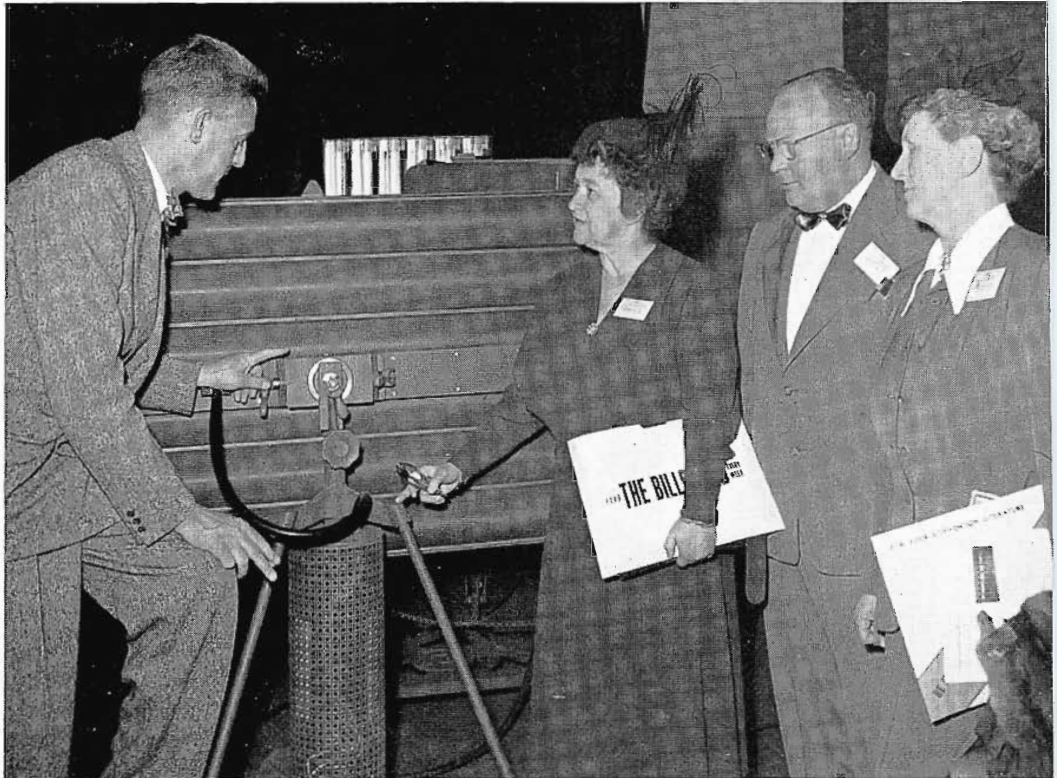

TELEVISION ASSOCIATES' Capt. W. C. Eddy points out features of dolly light to Mrs. A. S. Bullit and Gloria Chandler of KING, Seattle and RCA's Manager of Television Studio Equipment Sales, M. A. Trainer.

LIGHTING EQUIPMENT FOR TV STUDIOS

RCA's line of lighting equipment—a representative selection of which was on display at the NAB Convention—includes hi-intensity controllable fluorescents, incandescent units, Fairlead control guides, spotlight hangers, control boards and switching panels. All equipment is studio tested and may be supplied as a packaged system to match the lighting response curves of modern studio cameras. Lighting equipment systems for handling any studio setup can be furnished. Hi-intensity fluorescents easily provide 200 foot candles of uniformly distributed light. All lights are rotatable, may be tilted, and are designed for inverted pyramid mounting on studio ceilings. Studio lights are conveniently controlled mechanically from a central control board.

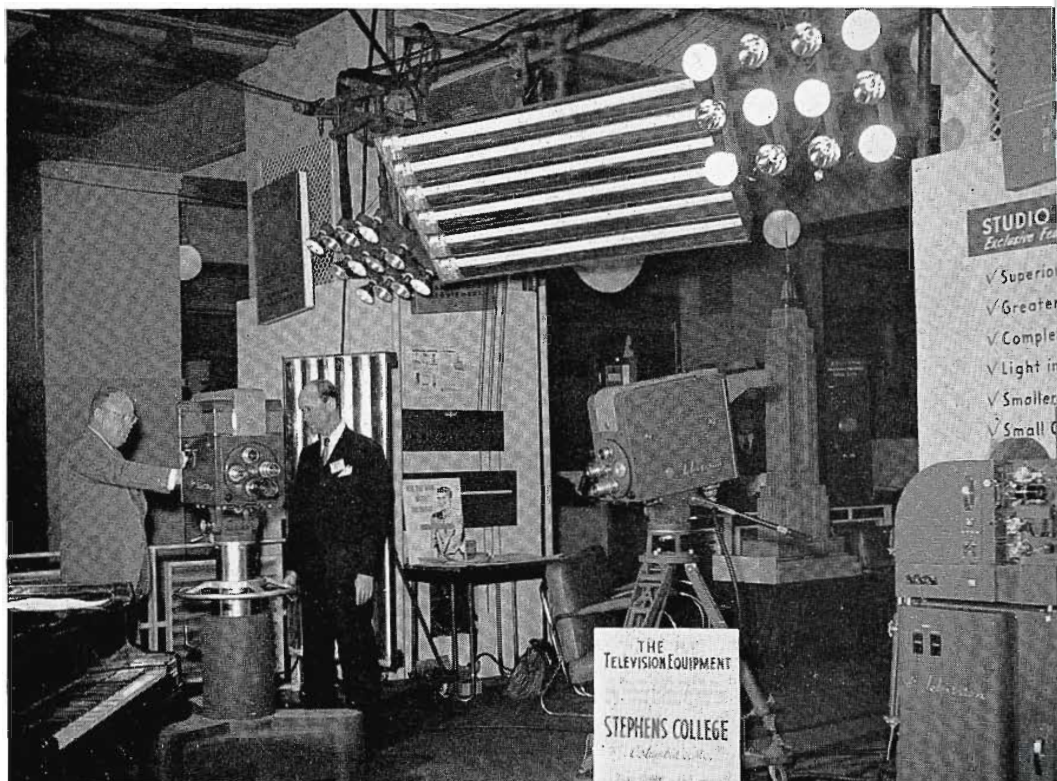

WTPS (Times Picayune, New Orleans) manager, H. F. Wehrmann (right) and M. A. Trainer talk cameras in the section of the RCA Exhibit which was arranged to simulate a TV studio, complete with lighting (and even talent, until envious competitors complained).

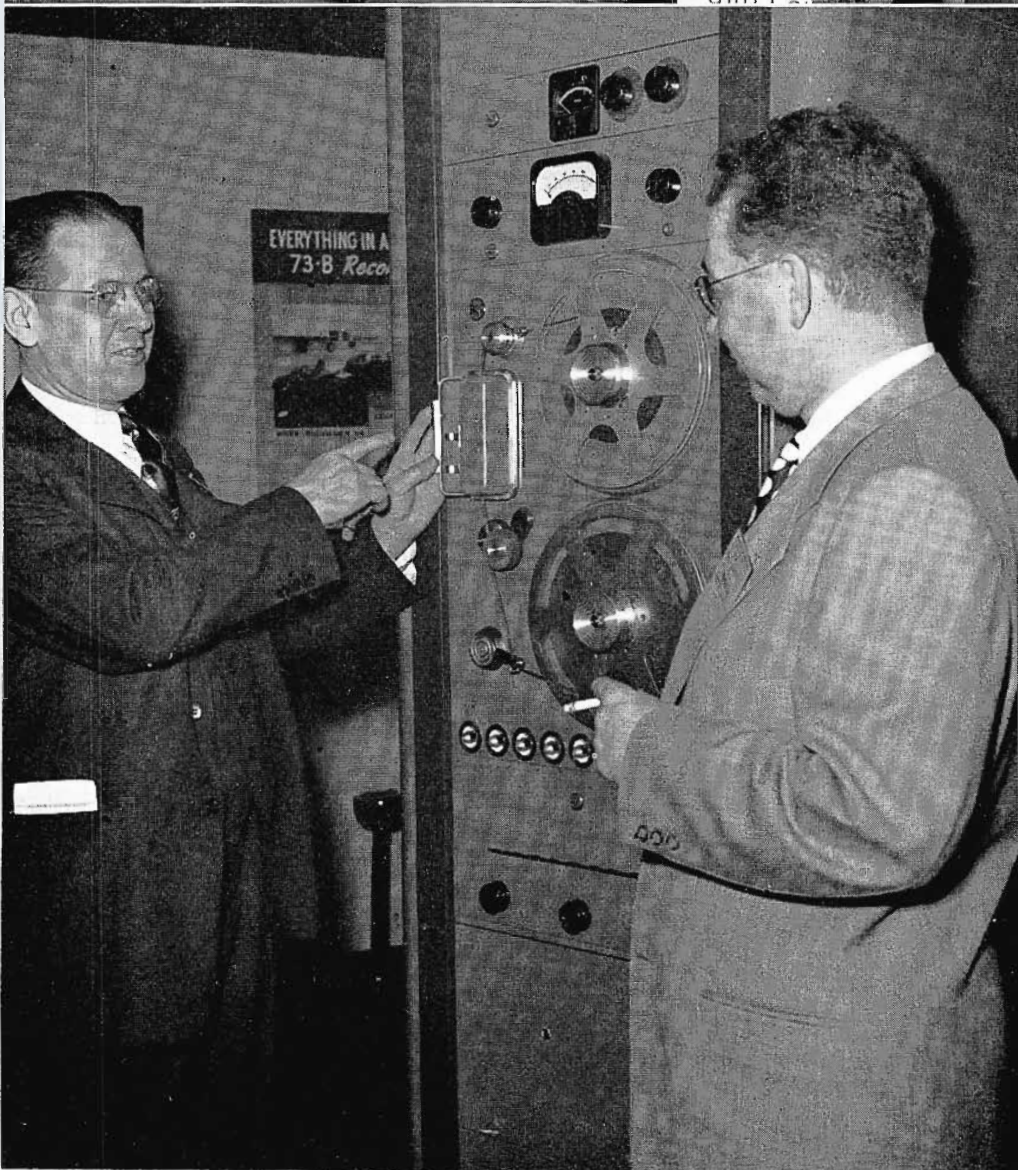
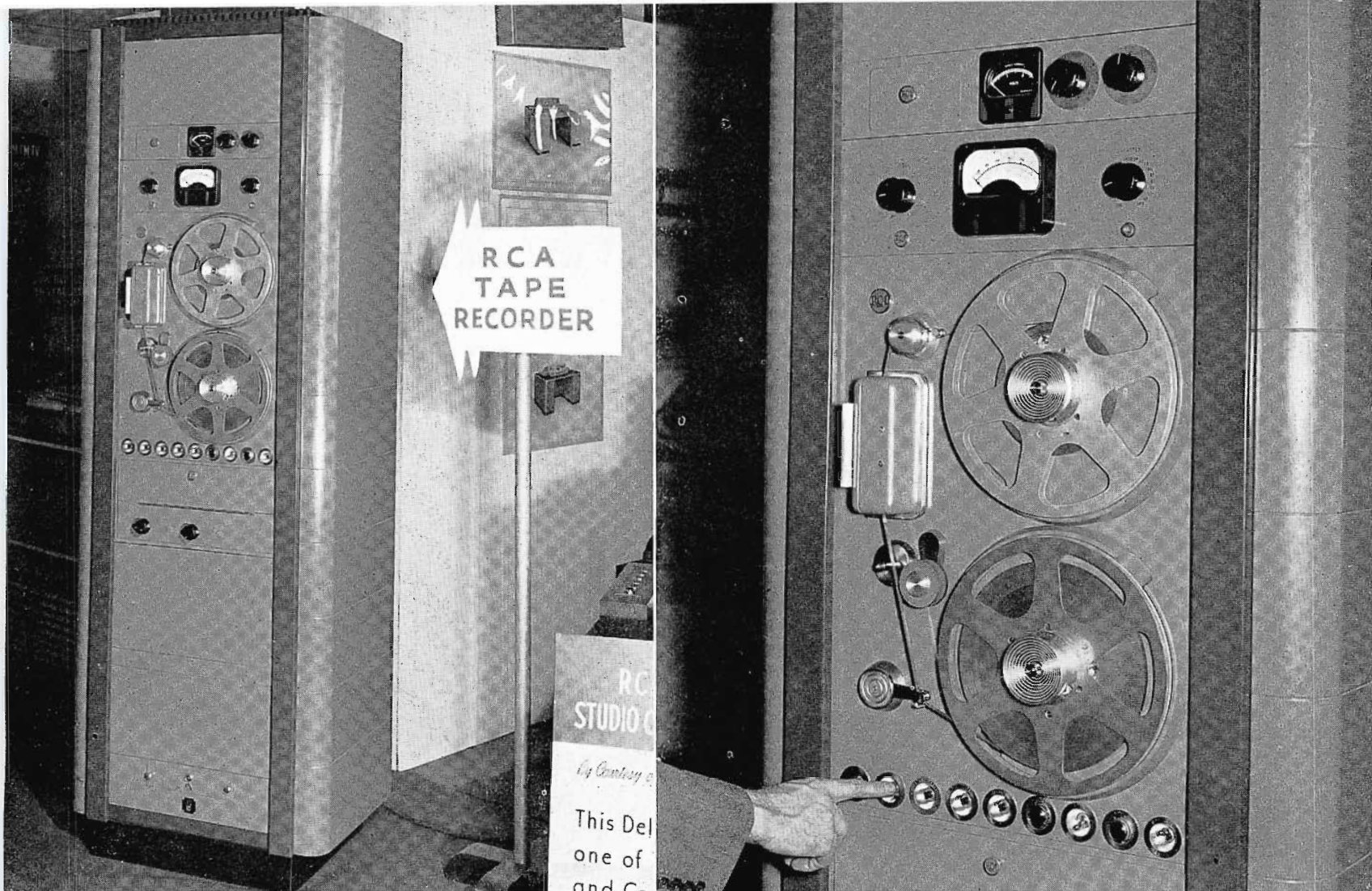

NEW TAPE RECORDER

The new Type RT-11A Tape Recorder is shown in the pictures on this page which were made at the NAB Convention where this new deluxe model recorder was shown for the first time. Incorporating all of the best features of early designs—plus a number of new features, the RT-11A is a deluxe model—designed for the perfectionist—the engineer who wants the best. Its synchronous drive insures accurate timing ($2\frac{1}{2}$ seconds in 30 minutes), the tape system starts and stops in a fraction of a second. A tape “breakage” switch applies brakes before tape can pile up on the floor, the start, stop, and reverse operations are controlled by push-buttons (which may be remoted, if desired) and there are many other features which experience has indicated are desirable for top operation.

ABOVE, LEFT: The new tape recorder may be rack-mounted, as shown in this view, or may be mounted horizontally in a console or desk.

ABOVE, RIGHT: Closeup showing push-buttons which control all operations. A remote control unit is optional.

LEFT: Mr. W. P. Williamson, Jr. of Station WKBN, Youngstown, discussing the RT-11A Recorder with W. L. Babcock, Manager of RCA Audio Sales.

PORTABLE TV FILM PROJECTOR

A portable film projector which you can take right out to the ball park—and use with a standard field camera for inserting your film commercials—was one of the interest catchers at the NAB. Complete in two small cases (weighing less than 50 lbs. total), this projector is designed to mount on a standard field-type camera tripod. A very simple mechanical coupling system allows it to be easily aligned with a standard TK-30A Camera as shown in the section at the right. When the camera is not being used to run film, it can be employed in the regular manner.

RIGHT: The new portable TV film projector setup for use with a TK-30A Camera (as it might be employed at remote locations).

BELOW, LEFT: Group examining the Projector-Camera setup at the NAB Convention. Note that operator can monitor operation on camera view finder.

BELOW, RIGHT: Carl Myers, Technical Director of WGN and WGN-TV, observes the film picture on the view finder. M. A. Trainer, Manager of RCA Studio Equipment Sales, looks on.



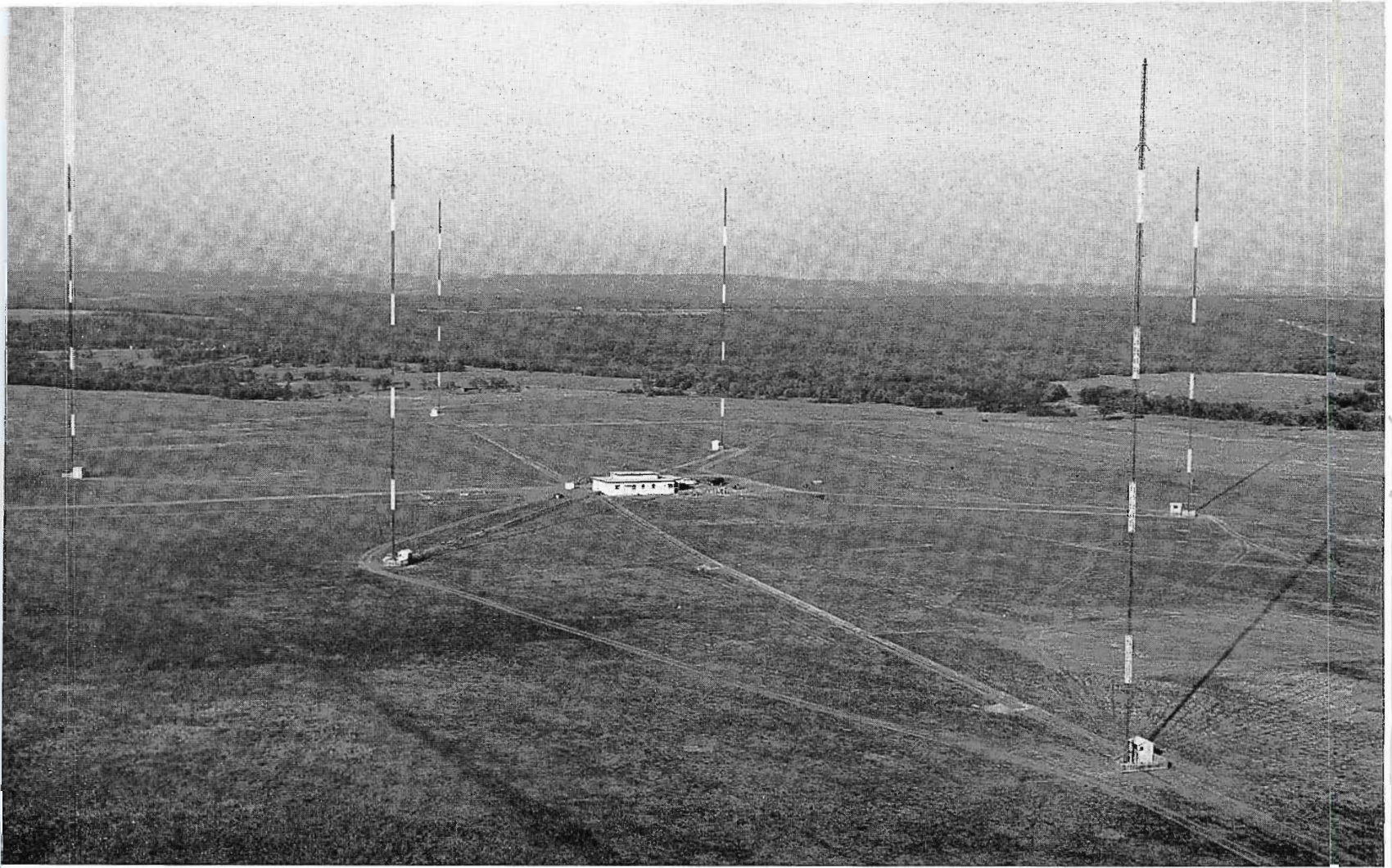

FIG. 1. 100-acre transmitting site of KRMG which is ideally located on a plateau not far from Tulsa. The land required no work prior to installation of the six-tower antenna system. Shown below is KRMG's new RCA 50 KW transmitter. Phasing equipment is built into the wall facing the supervisory console. Speech, monitoring and STL equipment is to the left of the console.



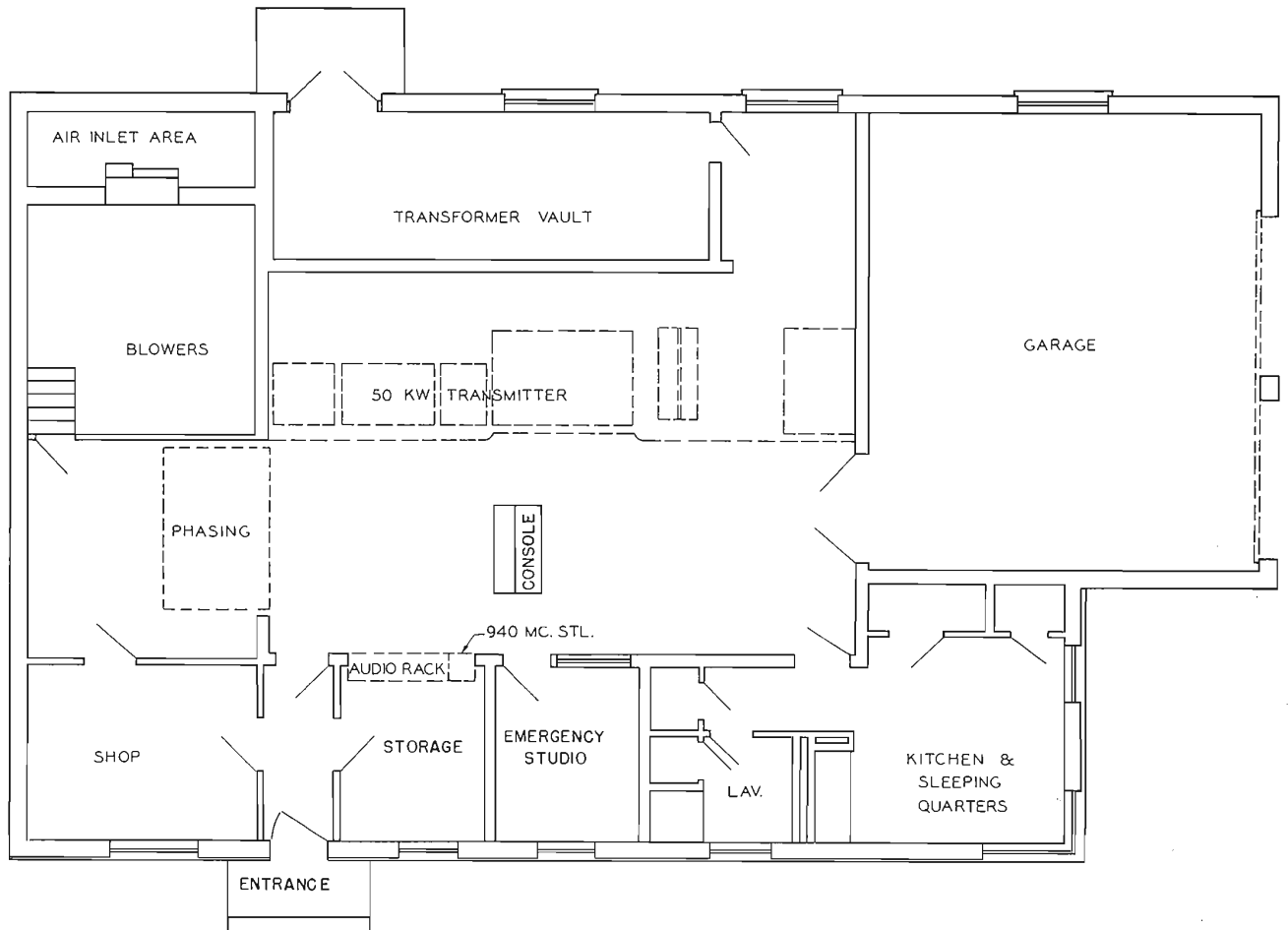
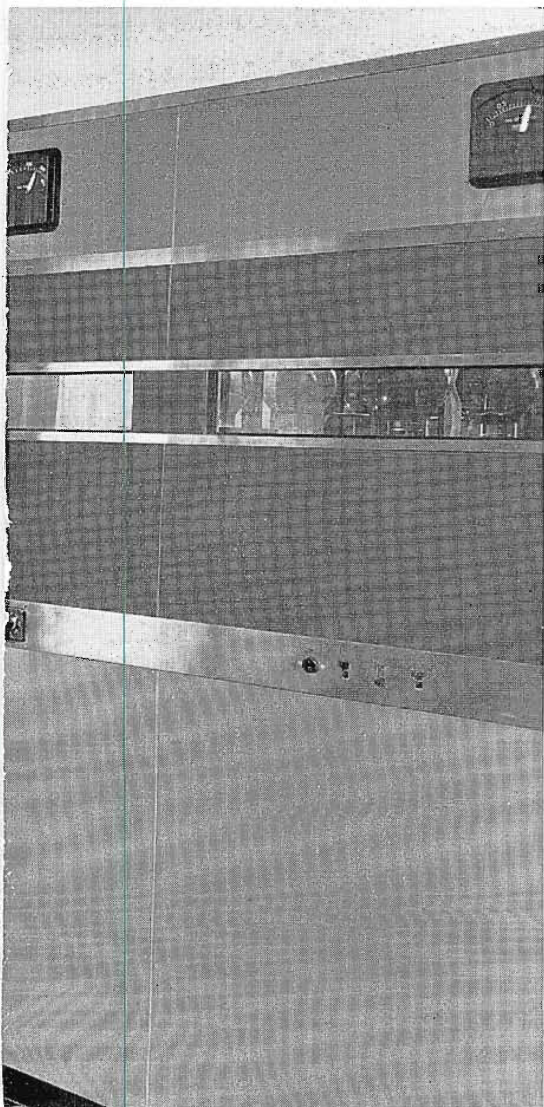

FIG. 2. Floor plan of the transmitter building which measures approximately 72 x 44 feet. Next to the storage room is an emergency studio which contains an auxiliary control panel with inputs to handle two microphones, two turntables, and the program circuit from the STL equipment. The studio building is located in downtown Tulsa, 18 miles away.



KRMG

TULSA'S NEW "FIFTY"

By

A. F. WOOSTER
Chief Engineer

K. W. McCRUM
Transmitter Supervisor

KRMG's new "fifty" is located eighteen miles west of downtown Tulsa as the crow flies—some twenty-six miles by road. The site was chosen after a great amount of survey work with an eye to the primary coverage of the Tulsa-Oklahoma City areas. The site is a natural one. Surrounded by rugged hills, KRMG's new "fifty" sits on a plateau of some one hundred acres as flat as the proverbial table top.

KRMG, which went on the air December 23, 1949, is owned by the All-Oklahoma Broadcasting Company, principal stockholders of which are Senator Robert

S. Kerr and D. A. McGee of the Kerr-McGee Oil Industries, Incorporated. The "All-Oklahoma station" is all the name implies. KRMG's 0.5 MV/V coverage includes at least a part of 63 of Oklahoma's 77 counties, plus 18 counties in Missouri, 14 in Arkansas, 13 in Kansas and 10 in Texas.

The actual construction period required but four and one-half months. One of the great time savers was the employment of solid di-electric co-ax which along with all the lighting, control, and metering circuits, is buried in sand-filled clay-capped trenches. The assistance of W. B. Fletcher,



RCA Service Company, in the completion of transmitter wiring was greatly helpful in making possible the short construction period. Some hardships were encountered during the construction period, however. At the outset a well had to be drilled to a depth of two hundred feet. The access roads were poor and during the construction fall rains prevailed. Despite the adverse weather the six towers were erected in a period of eleven days.

Antenna System

The antenna system employs six 275-foot radiators laid out in a parallelogram, with the in-line elements spaced 195 degrees. The ground system employs 120 radials 332 feet and 120 radials 50 feet. All intersecting radials are bonded on their periphery. The entire one hundred acres is literally planted with copper. The tuning houses are of copper bearing steel, which provides excellent shielding. Special care has been taken in the proper grounding of the tuning houses to prevent any possible shifting of tuning due to changing weather and temperature.

Helicopters were used to measure directional patterns. All measurements, with the exception of cross radials and monitor points were accomplished from the helicopters, a method wholly necessary because of the rugged inaccessible terrain surrounding the transmitter site. The tuning of the towers was completed in 13 days, thus many months were saved with the employment of these versatile aircraft. It is

FIG. 3. Photos at left show two views into the combined recording room and studio A control room. Control equipment consists of an RCA Type 76-C Console and Type BCS-1A Studio Switching unit. Lower photo shows the Type 73-B Professional Recorder in use.

FIG. 4. Diagram below is a floor plan layout of KRMG's studio building. Overall dimensions are approximately 164 feet by 48 feet.

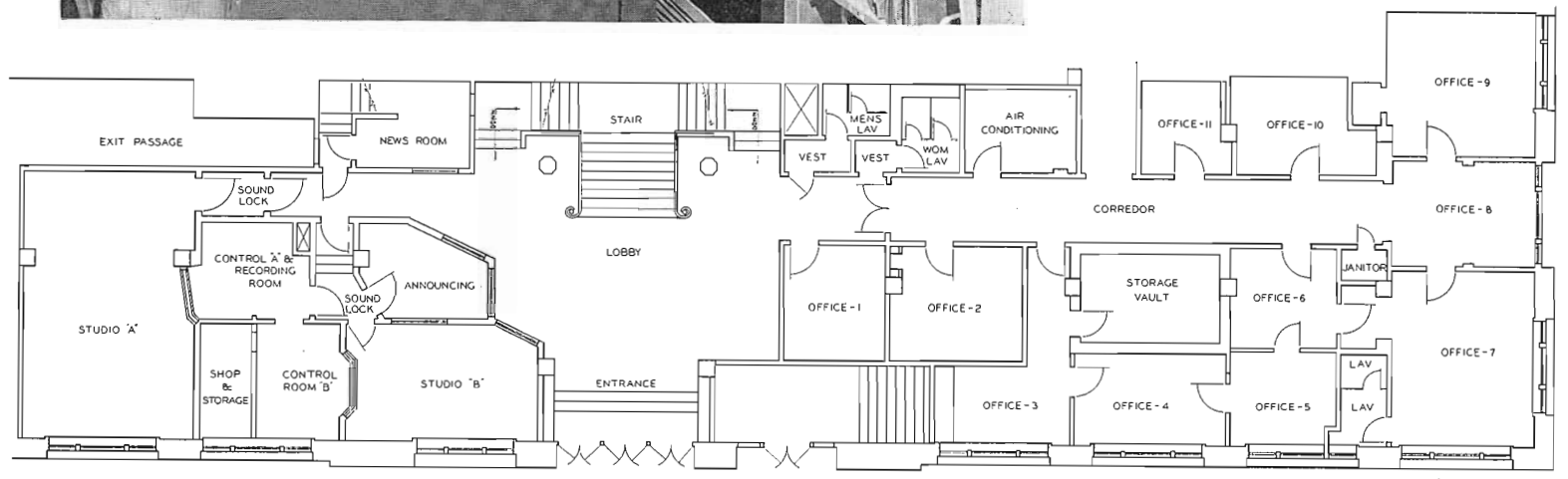

felt that measurements made in this manner are in fact more accurate than if made from the ground, due to the ever present pipelines so prevalent in the Tulsa oil territory. Austin lighting transformers are used to carry tower lighting voltage across the base insulator of the towers.

The transmitter room contains the RCA BTA 50 F-1 50 KW transmitter, the phasing units, the supervisory console, the speech and monitoring equipment, and the studio-transmitter link program system, which is operated in the 936 megacycle band. Directly in the rear of the transmitter enclosure is the fireproof transformer vault containing the high voltage potential transformers, the filter reactor, modulation transformer and modulation reactor. The vault has a protective fence separating the components from a walkway in such a manner that operating personnel may observe the contents of the vault during operation.

The blower room is located below, on a level with the plenum chamber. The blower room contains the main and the auxiliary blowers, associated motors, con-

stant cleaning oil bath air filters, sump pump, and motor control equipment.

The shop has more than adequate bench space and is complete with the usual tools and equipment. All structural steel, including the steel roof plating, is grounded to the antenna ground system with four-inch copper strap at the strategic points in the building. Care was exercised not to create closed current loops.

The emergency studio room contains a small auxiliary control panel with inputs to handle two microphones, two turntables, and, of course, the program circuit from the S.T.L. In the living quarters, there is a complete galley containing an electric range, refrigerator, garbage disposal unit, sink and cupboard units. The tube and small parts storage room is behind the speech racks. All rooms are provided with large casement type windows, insuring good lighting for trouble-shooting, etc. The garage area accommodates two cars and also houses the heating and air-conditioning plant along with all the primary switching and fuse panels.

The ease with which the transmitter plant is maintained at top efficiency has

pointed out the advantages of RCA's design and walk-in type construction. The circuits are straight-forward and simple, making for ease and speed of maintenance and adjustment. The overall efficiency of the BTA 50 F-1 is so good it is almost unbelievable. The new 5671 Thoriated filament tubes used in the final and modulator stages enable a savings in power that cannot be ignored.

The use of polycylindrical diffusion throughout the KRMG studios and control rooms helps maintain the unusual presence and liveness which the 76C consoles and associated speech equipment with their wide frequency response make possible. The acoustical treatment of the studios was designed by Frank McIntosh of McIntosh and Inglis.

The control room and studio walls are of dry wall construction with completely isolated studding and plates interwoven with the usual roll type insulation applied in overlapping four-inch layers. Isolation has proved to be equal to the most elaborate masonry type construction and resulted in a substantial saving in both construction time and cost.

FIG. 5. View of Master Control Room of KRMG, looking into studio B. A Type BCS-1A Master Switching System is located to the right of the 76-C Console. Note location of LC-1A Speaker above the control room window.



KANSAS CITY'S WDAF-TV

KANSAS CITY • MISSOURI

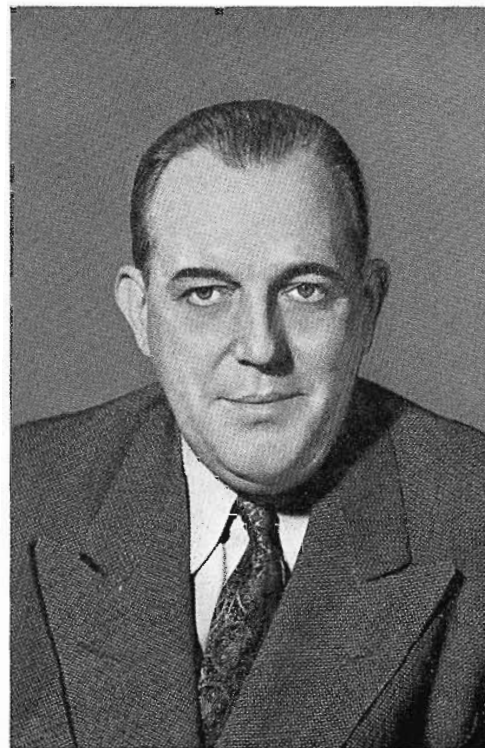

• Mr. Dean Fitzer, Manager of WDAF and WDAF-TV.

WDAF-TV raised the video curtain for Kansas City back in September 1949. Excellent reception of regularly-scheduled programs of film, studio shows and field pickups has been confirmed as far distant as Wichita, 178 miles away. WDAF-TV is Kansas City's only TV outlet.



THE KANSAS CITY STAR.

KANSAS CITY, SUNDAY, SEPTEMBER 11, 1949.
Television Comes to Kansas City Today Through Station WDAF-TV

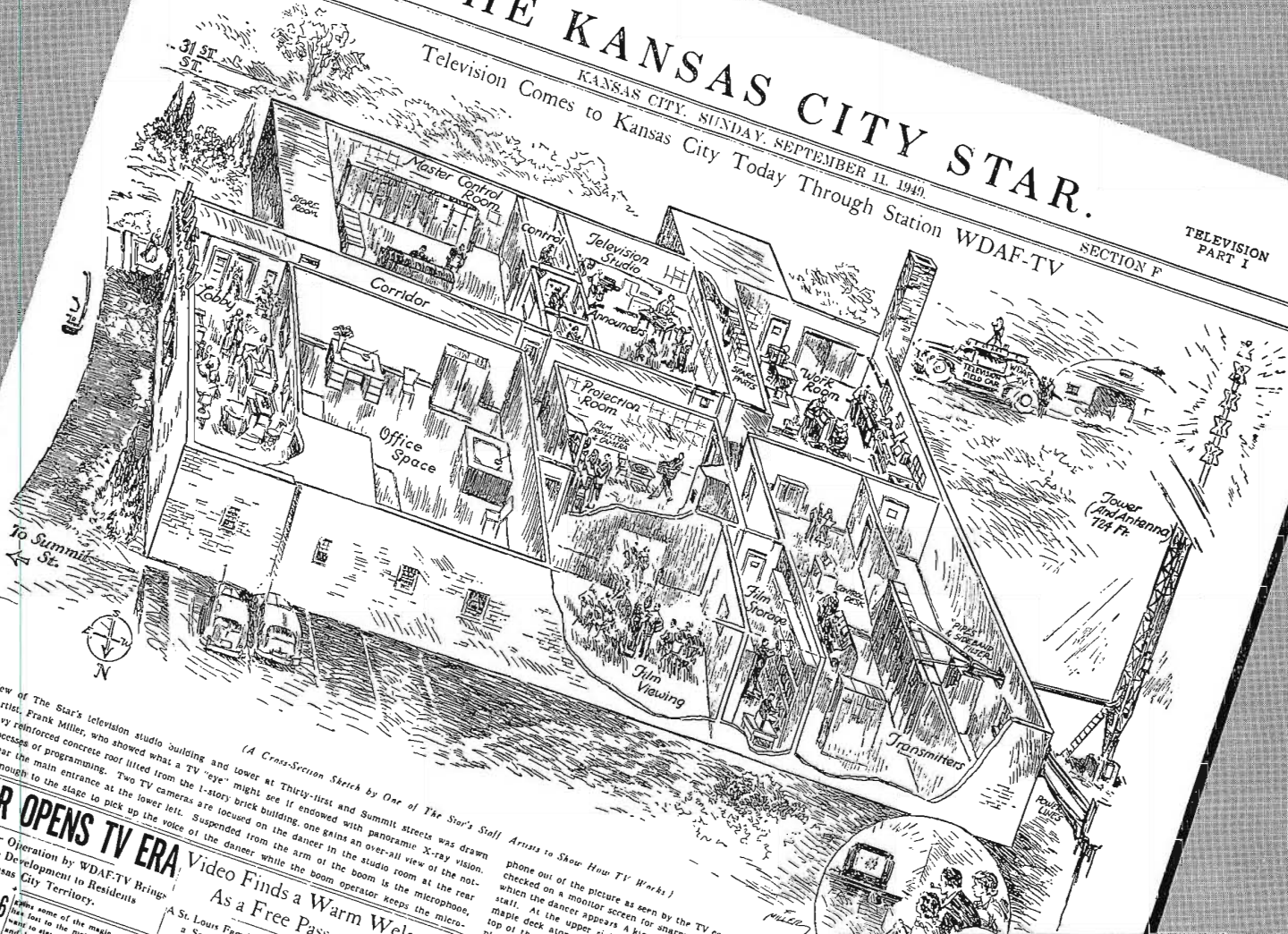

This view of The Star's television studio building and tower at Thirty-first and Summit streets was drawn by a staff artist, Frank Miller, who showed what a TV "eye" might see if endowed with panoramic X-ray vision. By the heavy reinforced concrete roof lifted from the 1-story brick building, an over-all view of the rear of the lobby near the main entrance at the lower left. Two TV cameras are focused on the dancer in the room at the rear which is near enough to the stage to pick up the voice of the dancer while the boom operator keeps the microphone out of the picture as seen by the TV cameras. In the master control room, the outgoing checked on a monitor screen for sharpness and tonal quality. In the film viewing room, adjacent to the master control room, the kinescope film program is being previewed by sponsors and members of the staff. At the upper right is the television film program being broadcast from the building, a maple deck atop this specially built vehicle. The televised program is broadcast from the building, a specially built vehicle. The artist's portrayal extends to landscaping and other features under way by the city. The building has been constructed so that it may be expanded outward and to have a second story.

THE STAR OPENS TV ERA

Regular Operation by WDAF-TV Brings Major Scientific Development to Residents of the Kansas City Territory.

Video Finds a Warm Welcome As a Free Pass to Everything

A St. Louis Family, Puzzled About a Christmas Present for a Semi-Invalid, Hits Upon the Idea and Now All Enjoy the Wide Variety of Programs.

A FREE PREMIERE

Receivers of All States and Prices Will Be Demonstrated by the Dealers.

THE HUGE DISPLAY IS READY

Public Invited to the J-Day Kansas City at 2 o'Clock This Afternoon.

TOP FAIR

Best Network Film Formed for the Year.

WIDE VARIETY IS

Comedy, Drama, Musical and Thriller Show A Under Contract.

PICK UP LOCAL EVIL

WDAF-TV Will Beam Royal in Its First Transmittion October 16.

Activities Will Be Held at the Motor Car Show at the Convention Center. The show will feature a wide variety of cars, including the latest models from the major manufacturers. It is expected to be one of the largest and most successful shows in the city's history.

One of the principal effects of jamming home at the end of the day is the fact that it allows the family to see the same program at the same time. This is a great convenience for families who live in different parts of the city. The service is also available to those who are unable to attend the show in person.

The magic moment of TV's hour will signal the start of an "impressive 3-day" television event. The event will feature a wide variety of programs, including comedy, drama, and musical. It is expected to be one of the most successful events in the city's history.

There are three general types of television sets available. The first is the portable set, which is small and can be carried around. The second is the console set, which is larger and sits on a table. The third is the floor set, which is the largest and most expensive. Each type has its own advantages and disadvantages.

These Younger Children are being taught to be good citizens. The program is designed to help children understand the importance of their actions and the impact they can have on their community. It is a valuable educational tool for parents and teachers.

The network programs which will be broadcast from Kansas City are of high quality. They include a wide variety of genres, from comedy to drama to musical. The station is committed to providing the best possible viewing experience for its audience.

The station is currently in progress for more. The program director is working on a variety of new shows and formats to keep the audience engaged and entertained. The station's commitment to quality programming is unwavering.

Transmitter and studio building shown at left is located at 31st and Summit Streets, not far from downtown Kansas City. Operating on channel 4 with an effective radiated power of 22,000 watts, WDAF-TV consistently serves an audience of nearly 1,500,000 people.



Mr. Roy A. Roberts, President and General Manager of the Kansas City Star Company, parent organization of WDAF and WDAF-TV.

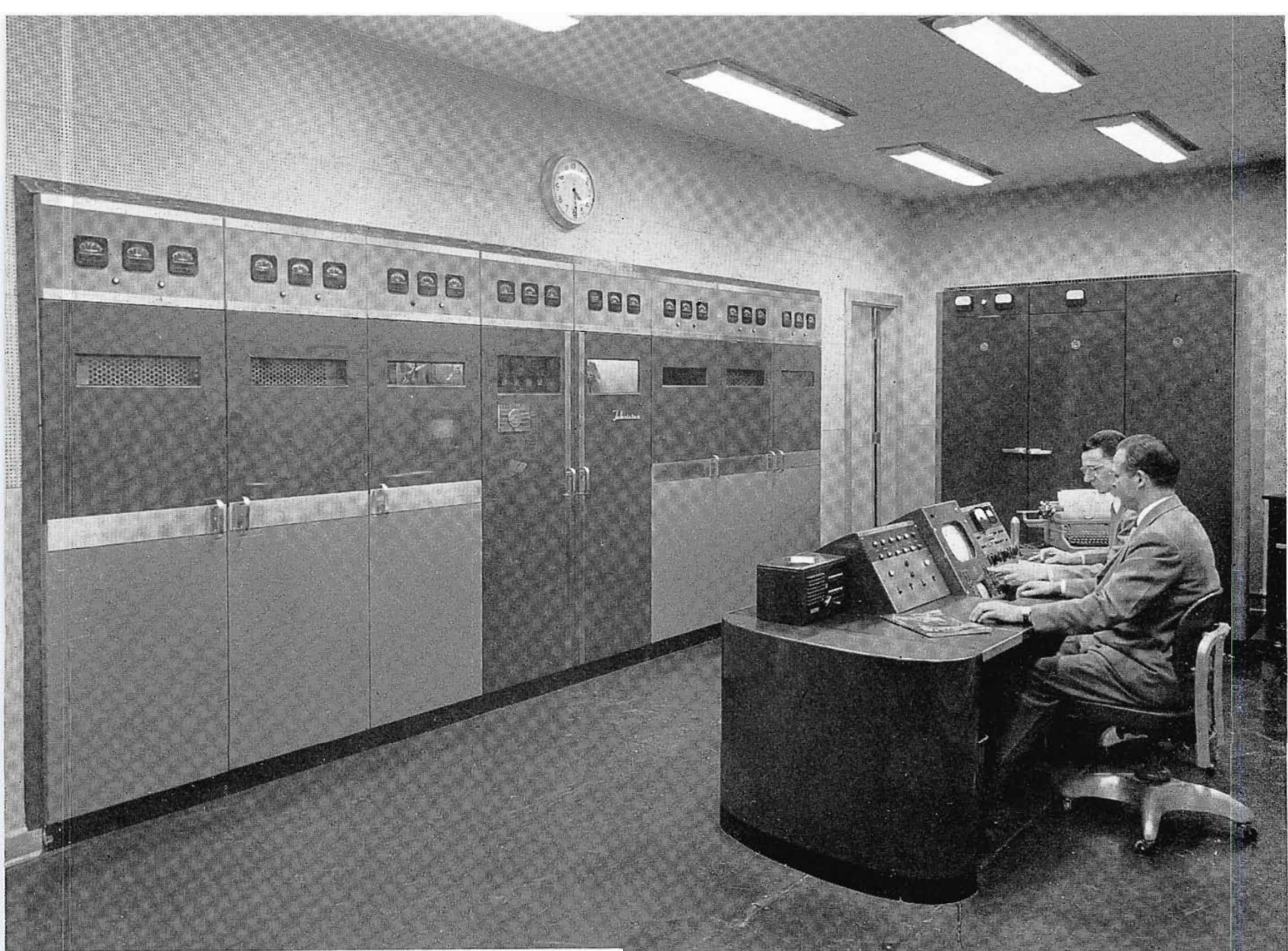

WARNER S

▲
 FIG. 1. Transmitter room of WDAF-TV showing built-in RCA TT-5A. Seated at transmitter console are Mr. Byron A. Carlisle and Mr. Stewart Williams, WDAF-TV engineers. Mr. Carlisle designed the microwave-relay rotating unit shown on another page.

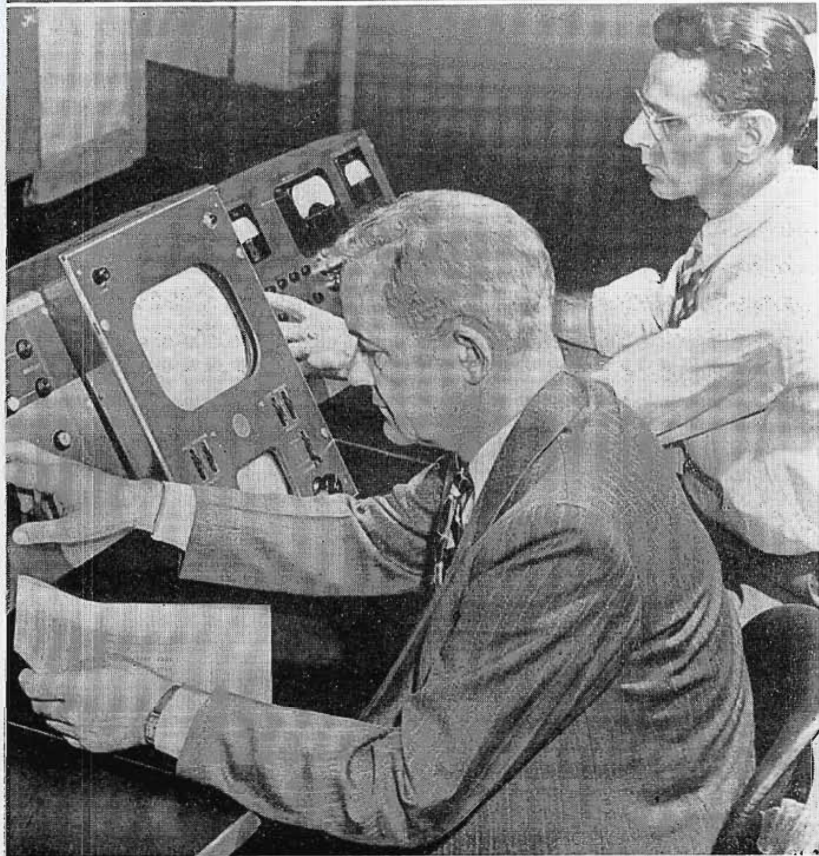

◀
 FIG. 2. Seated with Mr. Williams in this photo is Mr. Joseph Flaherty, Chief Engineer of WDAF-TV. Assistant General Manager of the station is Mr. V. S. Batton.

WDAF-TV ONE-FLOOR LAYOUT
 contains complete TV facilities including
 transmitter, studio, film, master control

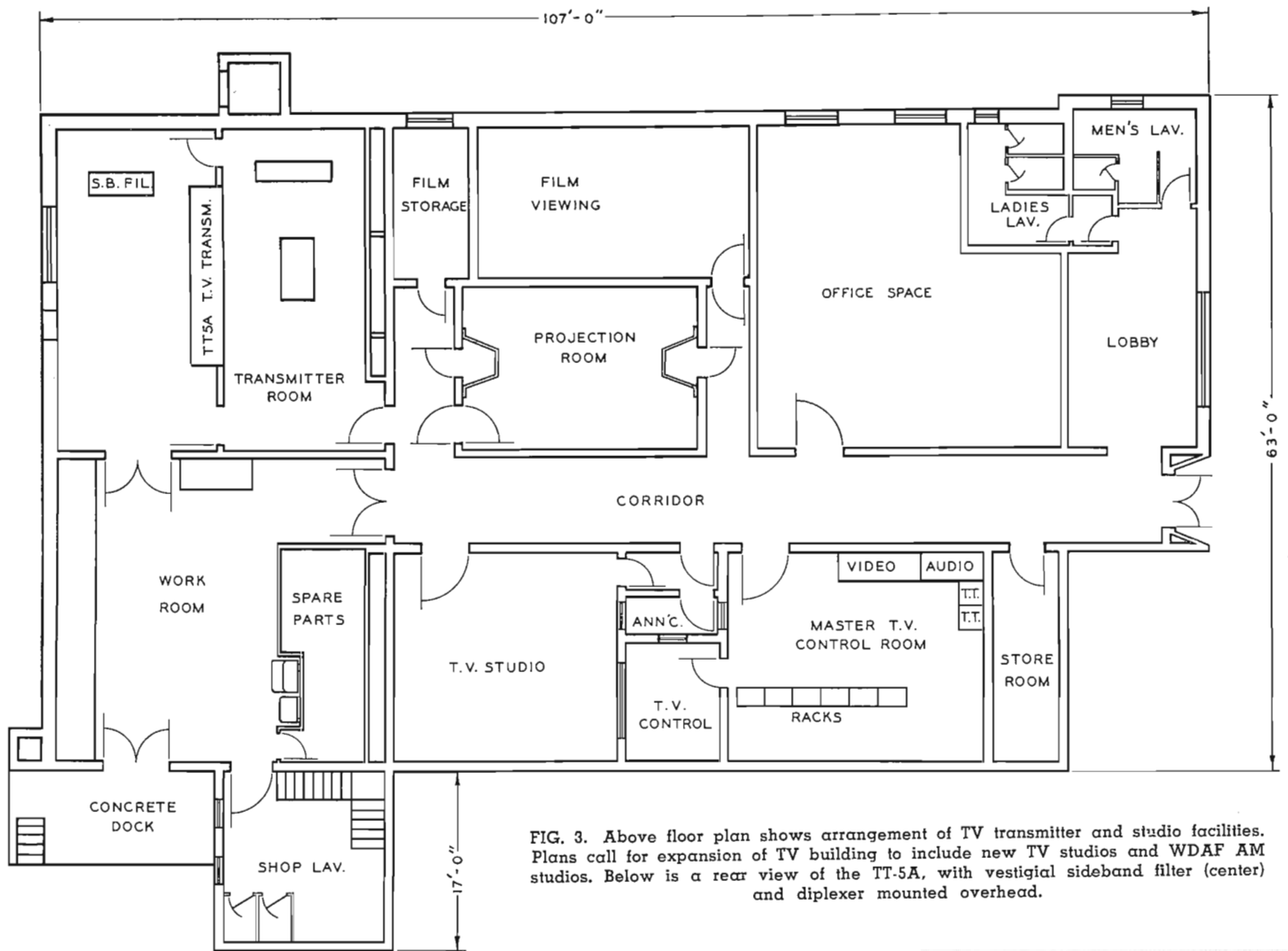
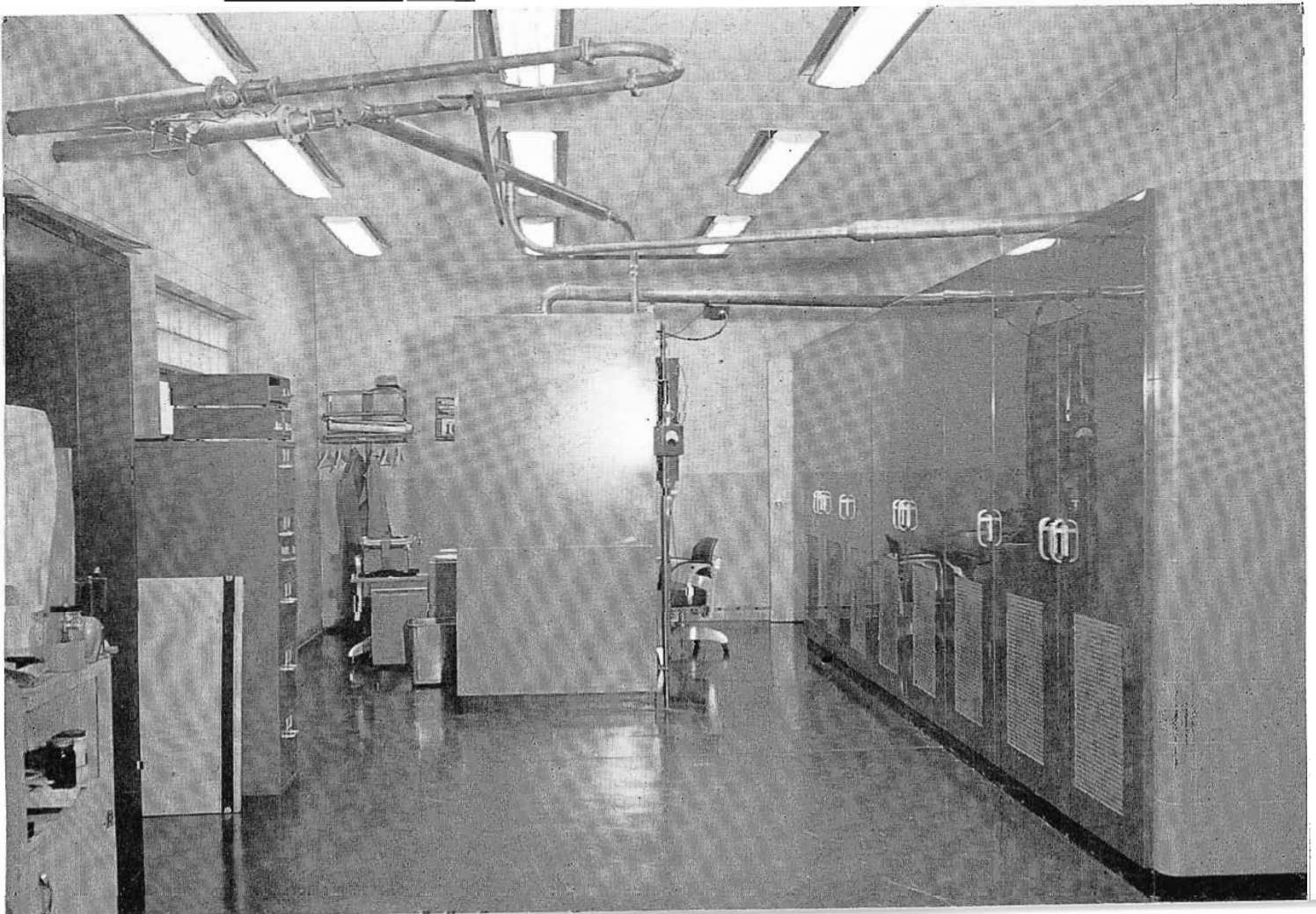

FIG. 3. Above floor plan shows arrangement of TV transmitter and studio facilities. Plans call for expansion of TV building to include new TV studios and WDAF AM studios. Below is a rear view of the TT-5A, with vestigial sideband filter (center) and diplexer mounted overhead.



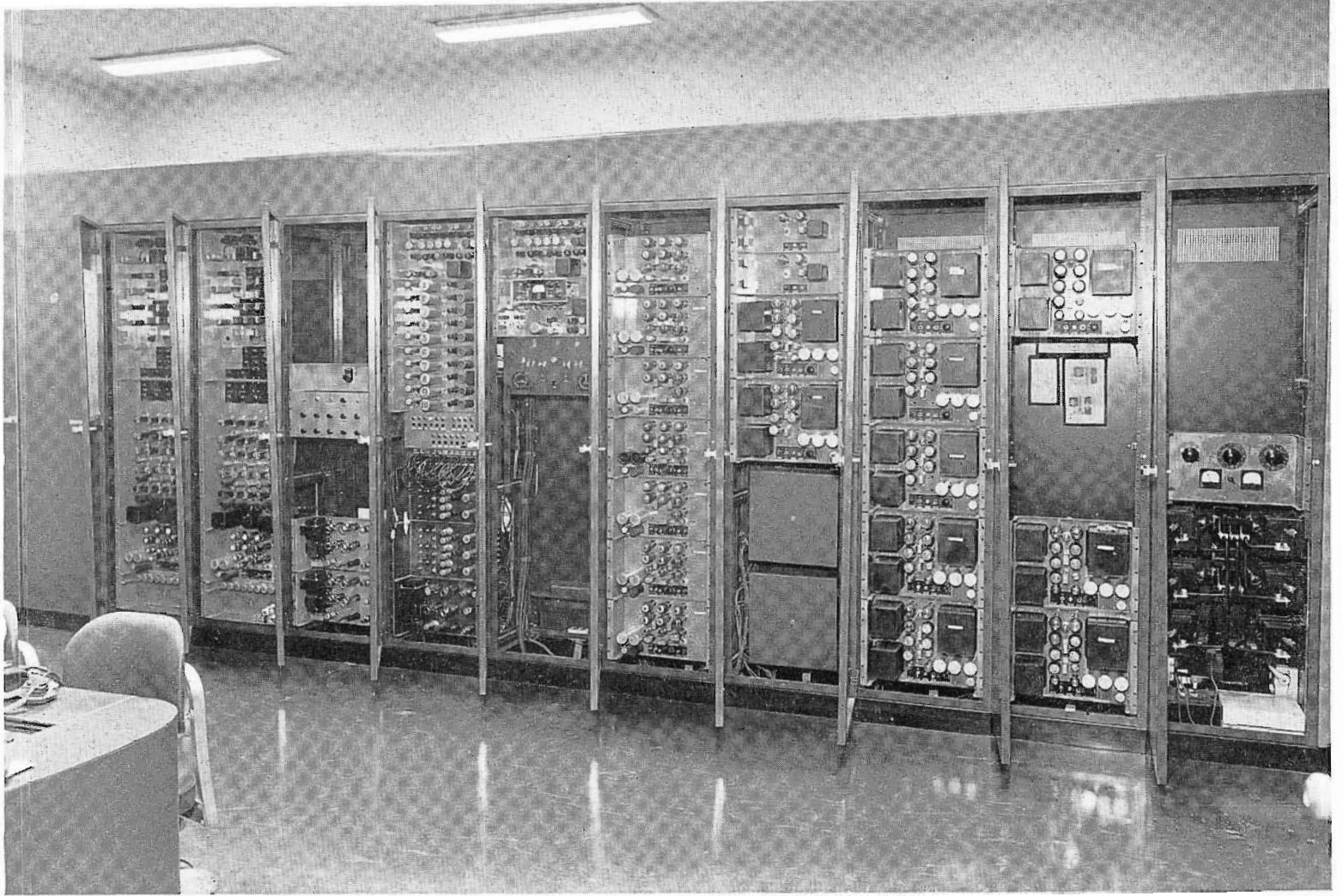

FIG. 6. Open door view of the equipment racks shown in Fig. 4. Closed rack is for telephone terminations. Open racks, left to right, are: racks 1 and 2, sync generators; rack 3, sync generator switching panel, grating generator and power supplies; rack 4, video jacks, TS-1A switcher, distribution amplifiers; rack 5, microwave relay receiver and rotator control panel; racks 6, 7, 8 and 9, power supplies; rack 10, 6.3 volt d-c supply for all low-level video filaments.



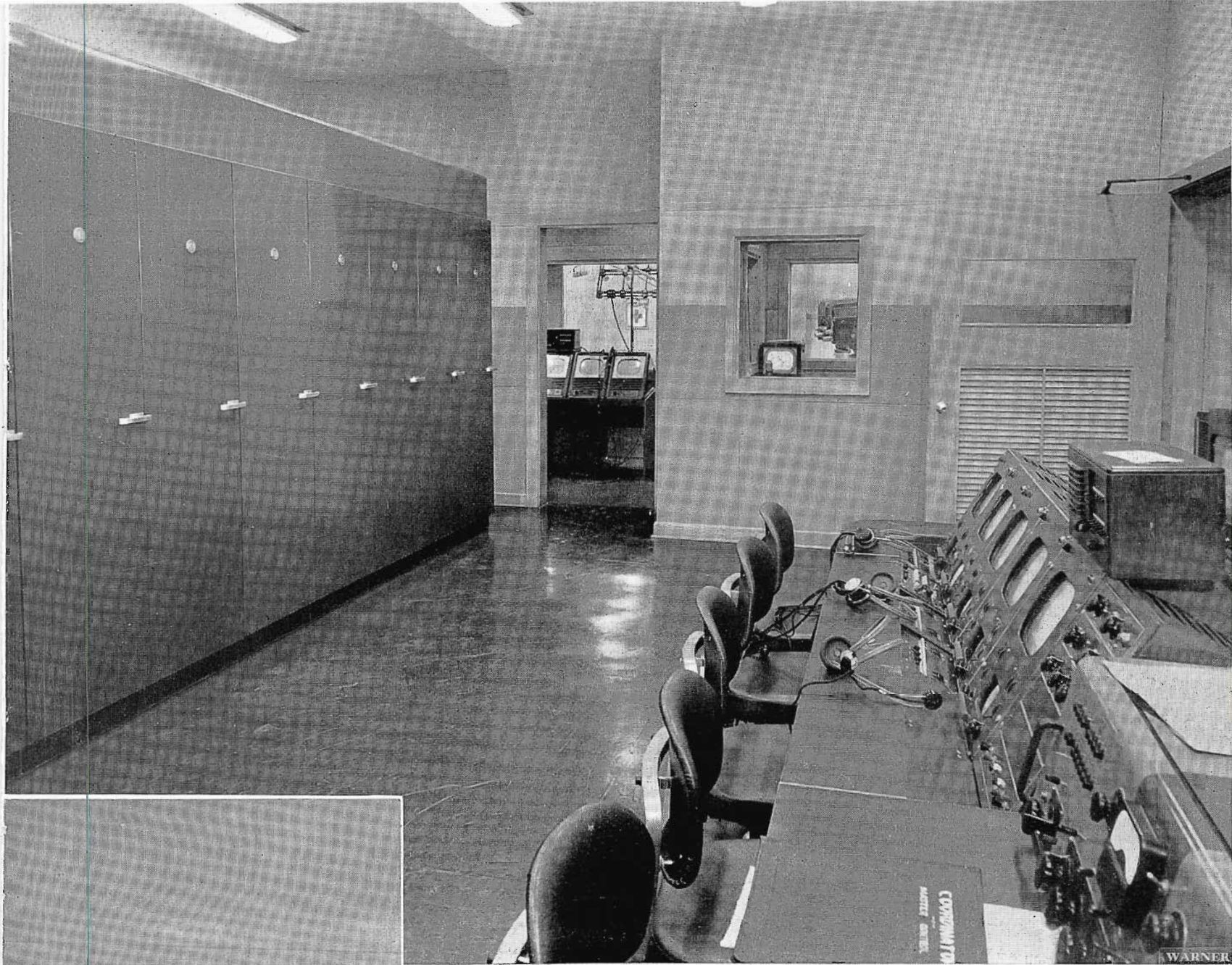

FIG. 4. View into WDAF-TV master control room where all switching operations take place. Small room (in front of camera) is the announce booth. Other small room to the left is a production booth, looking into studio.



IEWS OF WDAF-TV MASTER CONTROL

where program switching and even
studio camera switching is done

FIG. 5. View of the audio and video console in master control. Camera switching as well as master switching is performed at this console. Operators work entirely "blind." The RCA receiver is an "off-air" monitor.

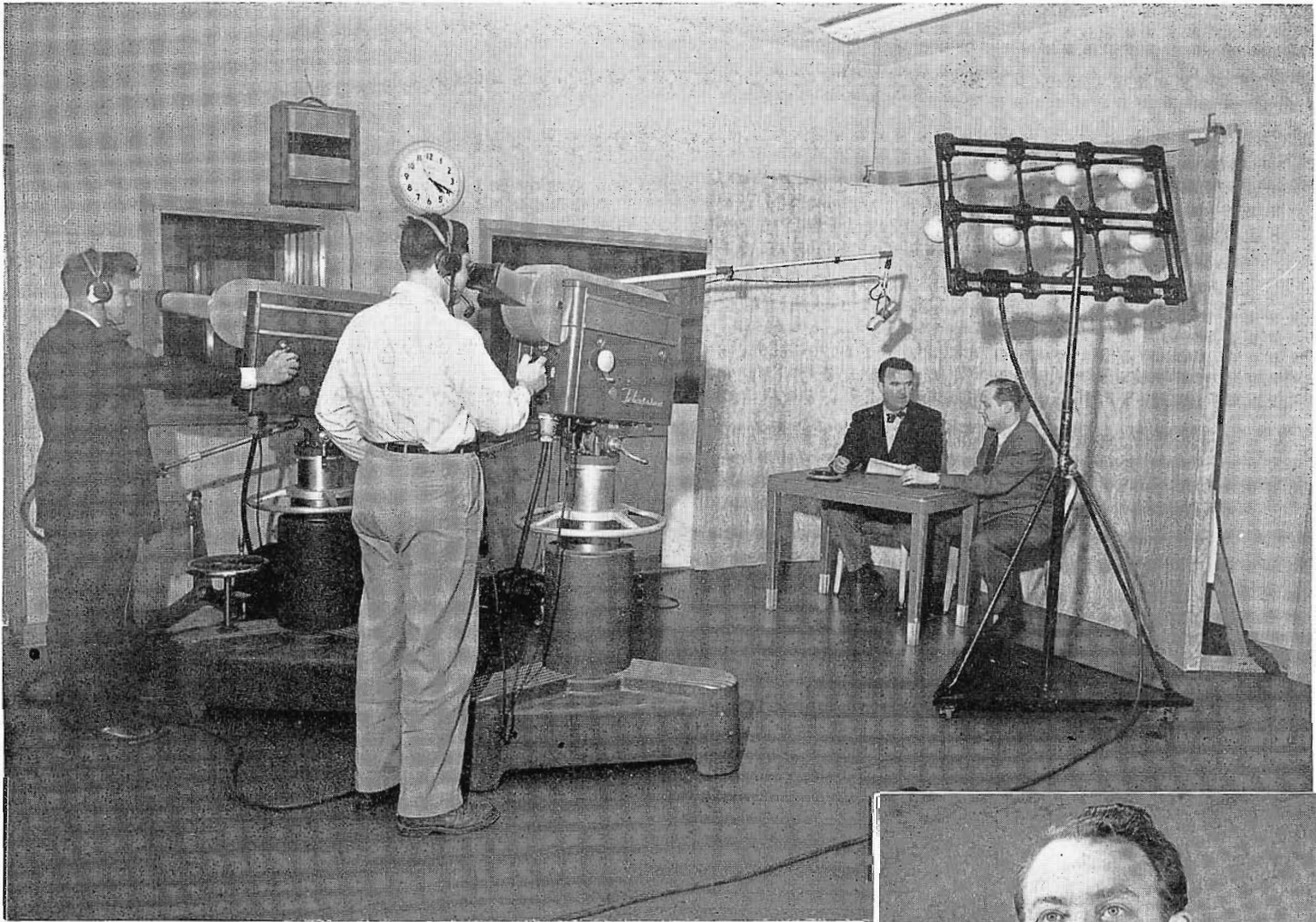

FIG. 10. WDAF-TV studio measures approximately 20 feet by 24 feet. Window at left is the announce booth. Other window is in the production booth. Camera engineers in this photo are Mr. James Schmidt (left) and Mr. Gerald Bower. Seated are Mr. Randall Jesse, Assistant Program Director, and Mr. Philip Bodwell, Producer-Director.

FIG. 11. Below is WDAF-TV custom built field car which carries the field pickup gear. Microwave relay dish is transported on roof of car.



Mr. William Bates, Program Director of WDAF-TV.

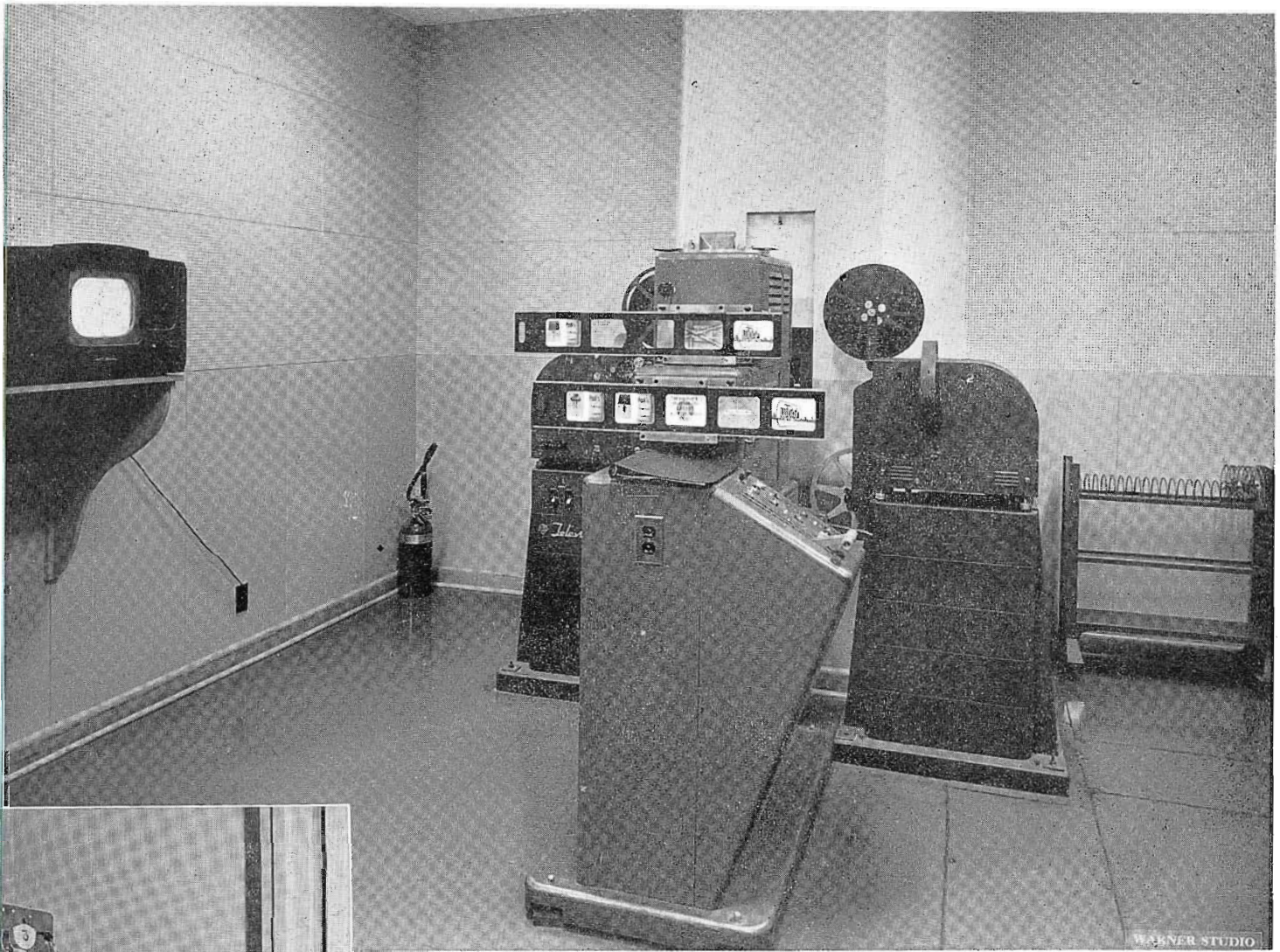

FIG. 7. WDAF-TV film projection room showing two 16mm projectors and the Gray Telop for transmitting the opaque slides. An RCA receiver is used as a line monitor. Note covered floor-trenches which carry all wiring for the projection equipment. These trenches were installed in many parts of the building, even to outside walls for future expansion.

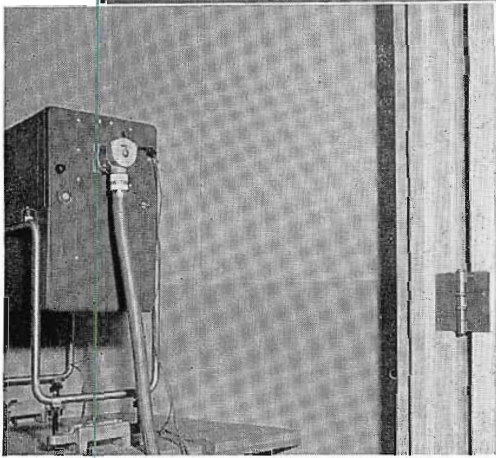

FIG. 8. Inset above is a view of the film camera, which is installed in the chimney-like offset in Fig. 7. The film camera was separated in this way from the projectors to conform to a local ordinance which required the construction of a fireproof room.



FIG. 9. At right is a view of the other side of the projection room. Projectionist seated at the editing equipment is Mr. Charles Ford. This photo shows another small offset (behind desk at left) for installation of another film camera.

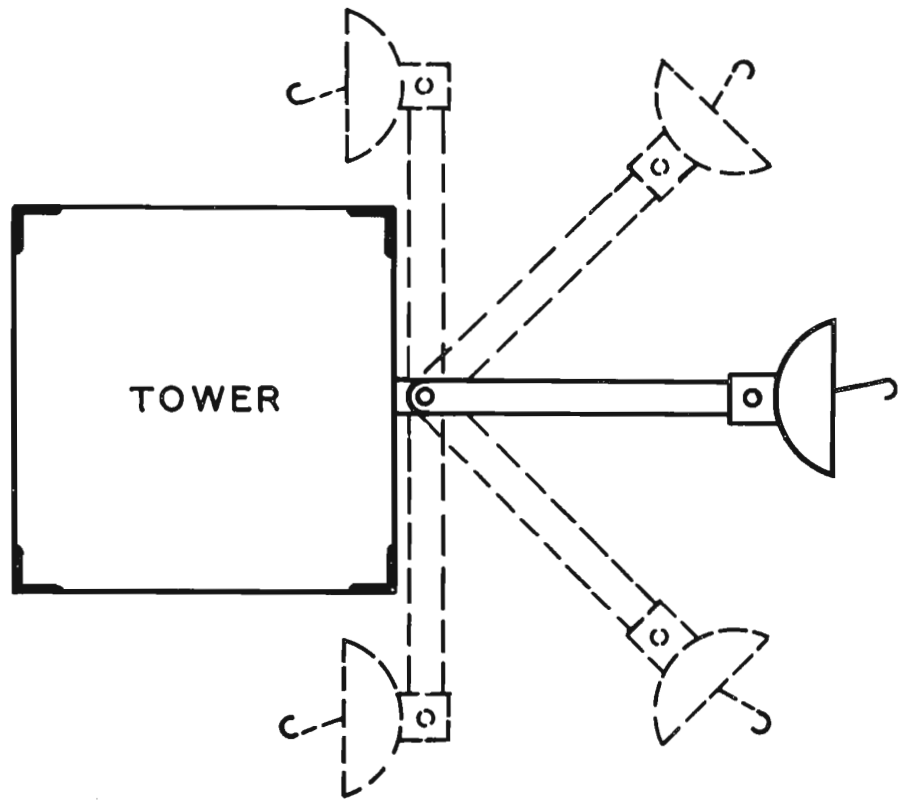
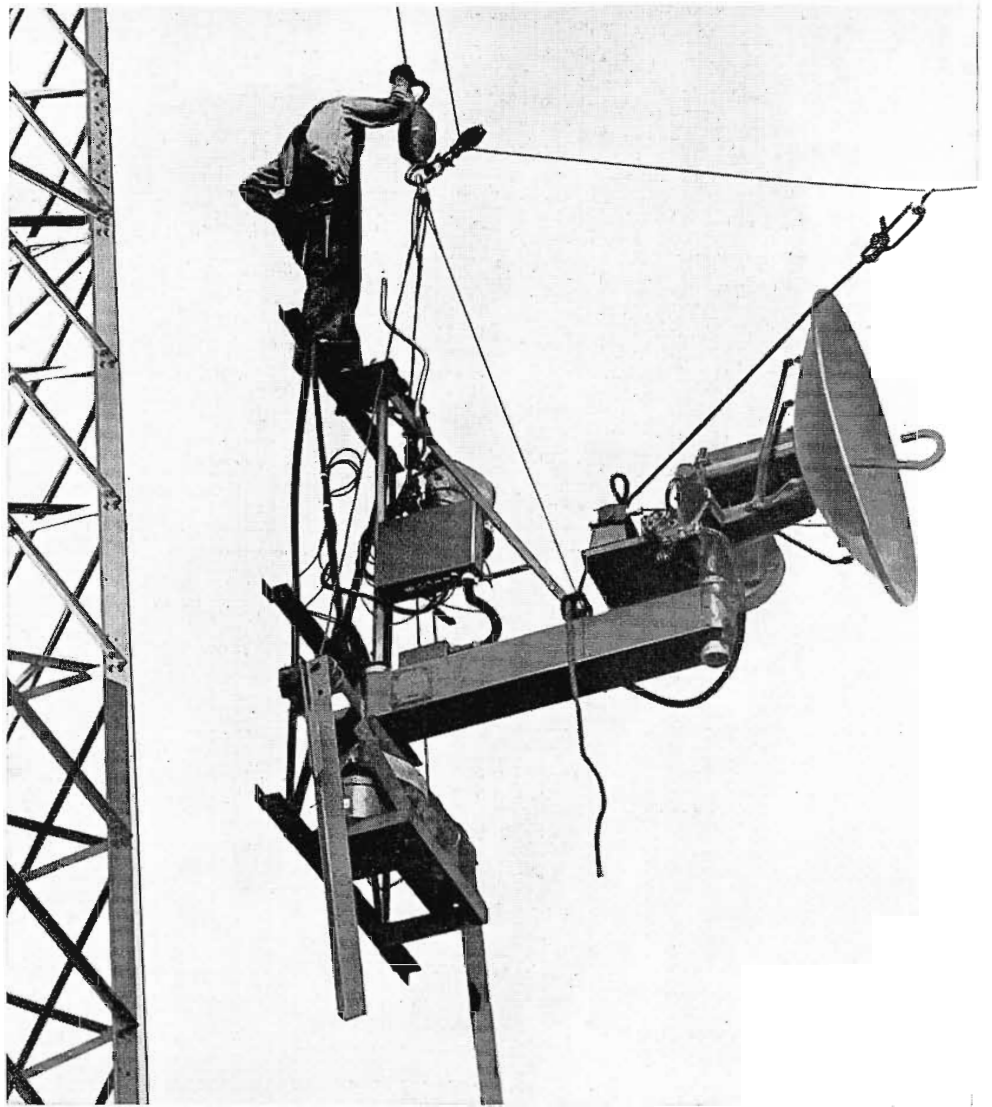
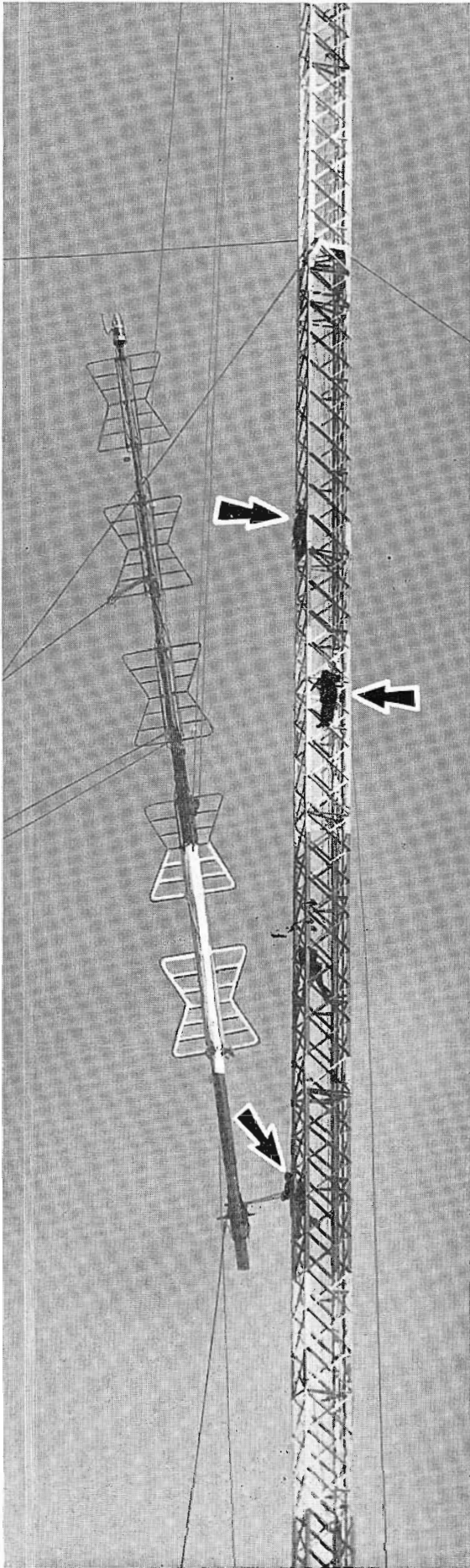

FIG. 12. View of the 650 foot Lehigh tower which supports the five-section Super Turnstile antenna of WDAF-TV. Tower cross-section is four feet square; height to top of antenna is 724 feet. Microwave equipment shown at left had not been mounted when this photo was taken.

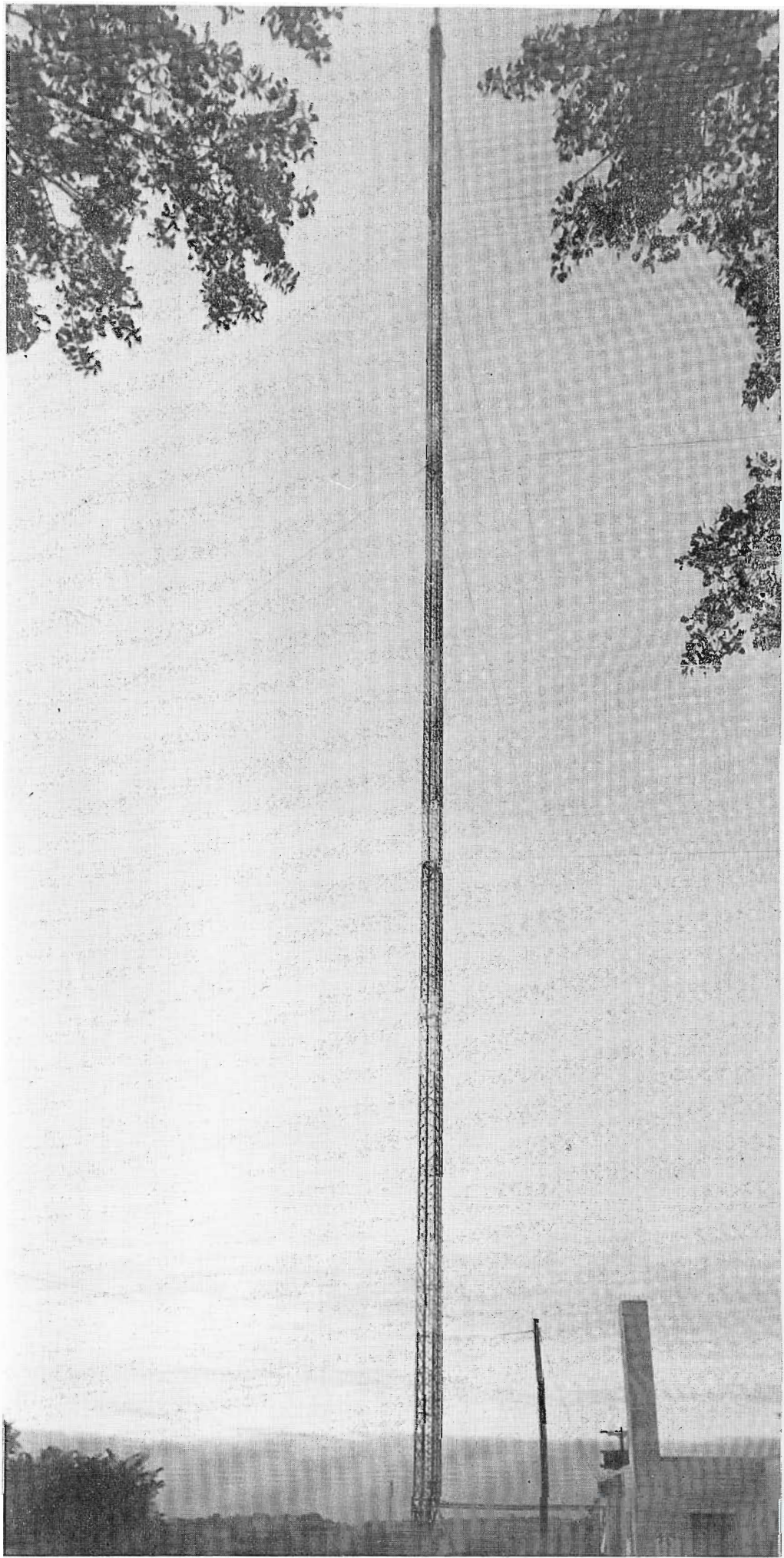

FIG. 13. Microwave equipment being hoisted to the 300-foot level for installation on the tower. A special rotating unit designed by Byron A. Carlisle, WDAF-TV Engineer, enables the relay dish to "look around" the tower in all directions.

FIG. 14. Diagram at left shows how relay equipment mounting plate and support boom are pivoted to allow rotation. The parabola (and receiver) rotate 360°; the boom rotates 180°. Vertical elevation is also provided. The rotating mechanism is remotely controlled. Photo at extreme left is a closeup view of the TV antenna being hoisted up the guyed tower.

DEVELOPMENT OF MULTIPLE-STATION ANTENNA



ABOVE: Dr. Frank G. Kear (left) of Kear and Kennedy, consultants representing the Empire State Building on the Primary Committee, C. W. Lyon, Jr. (center) Executive Vice President of the Empire State Building, and W. W. Watts, Vice President-in-charge of the RCA Engineering Products Department discussing plans for developing multiple antenna facilities for five separate TV stations on the Empire State Tower.

Plans to make the Empire State Building the focal point of telecasting service in the New York area took a big step forward with the signing of a contract on June between the RCA Victor Division of the Radio Corporation of America, and representatives of Empire State, Inc., and the National Broadcasting Co., Inc. The contract calls for development of a multiple television and broadcasting system atop the world's tallest structure.

Consummation of the agreement, a vital step in the plan to provide New York broadcasters with the best in television transmission, was jointly announced by a committee comprised of O. B. Hanson, Vice President and Chief Engineer of NBC, and Dr. Frank G. Kear, of the engineering consulting firm of Kear and Kennedy, Washington, D. C., representing Empire State, Inc.; and by W. W. Watts, Vice President in charge of the RCA Engineering Products Department.

The super-antenna project, planned to provide facilities for television stations WCBS-TV, WABD, WJZ-TV, WPIX, and WNBT, and FM stations WNBC-FM, WJZ-FM, and WCBS-FM, would result

BELOW: New television antenna, one of five designed for multiple antenna system on the Empire State Building, is shown during recent inspection of test site. L. J. Wolf, of RCA, at extreme left, Dr. Frank G. Kear, of Kear and Kennedy, and C. W. Lyon, Jr., Executive Vice President of the Empire State Building, look on while R. S. Grimm, RCA Engineer, monitors test equipment. Group of interested onlookers at right includes: H. Gihring, RCA; D. Bain, RCA; Tom Howard, Chief Engineer of TV station WPIX; E. S. Clammer, RCA; E. May, RCA; Bernard Lewis, Publicity Director for Empire State.

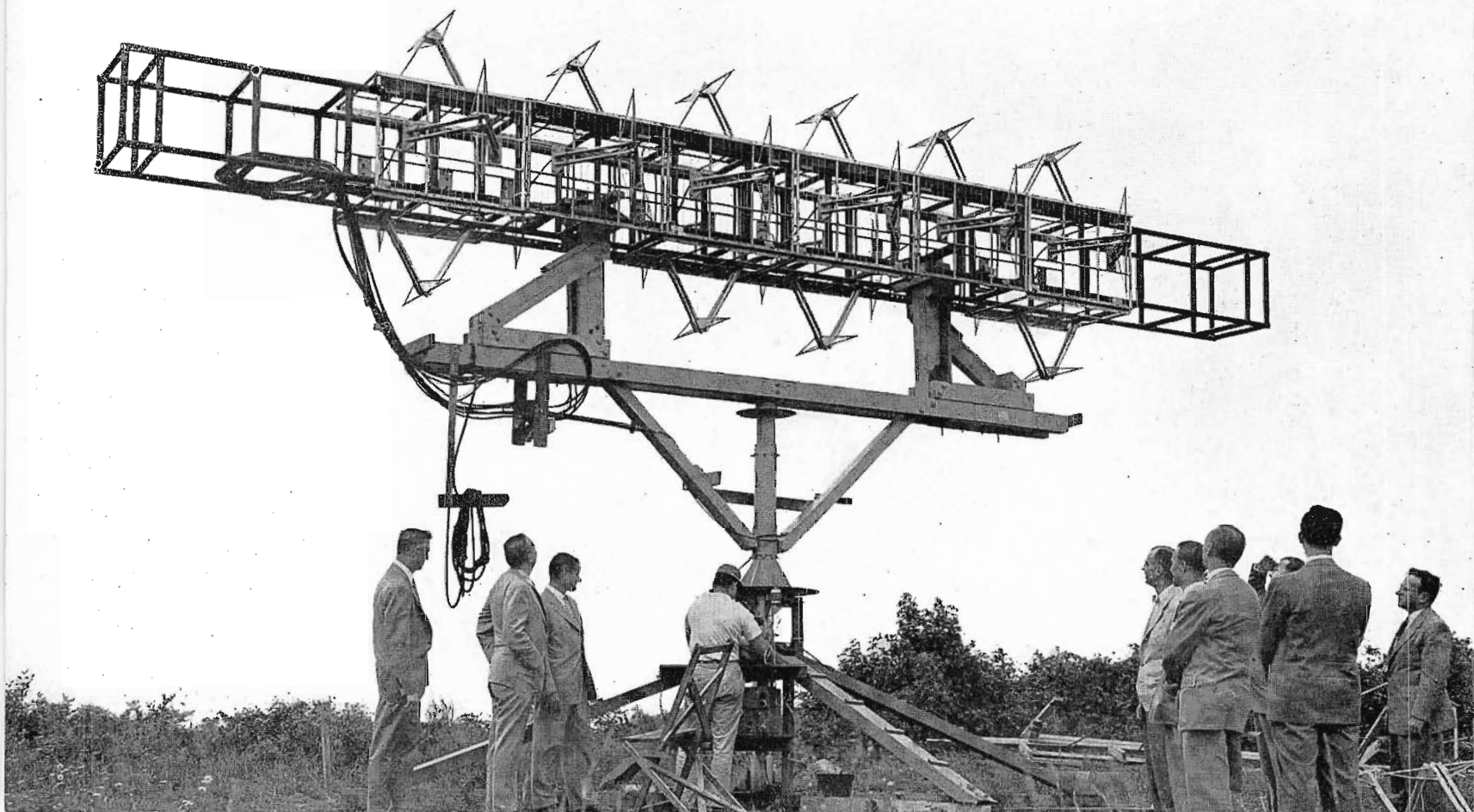

FOR EMPIRE STATE BUILDING NOW UNDERWAY

in better reception for millions of set owners in the Metropolitan New York area.

Empire State, Inc., proposes to erect on its building a specially engineered supporting structure for five TV antennas and three FM antenna systems. The project also contemplates installation of two emergency TV antennas on the mooring mast of the building. Under terms of the development contract, RCA engineers will determine the feasibility of operating these antennas simultaneously without objectionable interference. Other provisions of the contract call for complete examination of all technical problems.

Work under the contract will be started in the television laboratories of the RCA Engineering Products Department in Camden, N. J., as soon as participating stations and networks provide antennas for the project.

The RCA Engineering Products Department will erect five full-scale towers in Camden for use in the antenna tests. The antennas will consist of RCA supergain types for Channels 2, 5, 7, and 11, and a special RCA superturnstile for Channel 4. The separate emergency TV antennas, as well as the FM antennas, will also be included in the experimental work.

RCA announced the retention of Wayne Masters, of Ohio State University, as chief consulting engineer for the study.

Main advantages of the common antenna site are its height and centralized location. Since height is a vital factor in clarity and range of television transmission, better coverage and better signals are expected. Another advantage of centralization of transmitters of several telecasters at one site is that it will simplify orientation of local

home video antennas. This should result generally in better home TV reception.

No interruption of television service by any of the participating stations is contemplated during installation of the new facilities, it was stated. Stations now using the Empire State site have been supplied with a temporary RCA antenna for use in the interim during which construction is under way.

The new television structure will become an integral part of the structural frame of the Empire State Building, and will bring the height of the building to about 1500 feet above sea level.

The use of the building as a video transmission point started in 1931, when the late Gov. Alfred E. Smith, then president of Empire State, Inc., and Brigadier General David Sarnoff, RCA board chairman, concluded an agreement giving NBC an exclusive lease for TV transmission from the site. On expiration of the lease last year, the site was opened as a common transmission point for several stations on a share-the-cost basis.

Earlier this year, ABC's Station WJZ-TV arranged to share the site with WNBT, and other metropolitan stations began negotiations which led to plans for the multiple-video transmission tower.

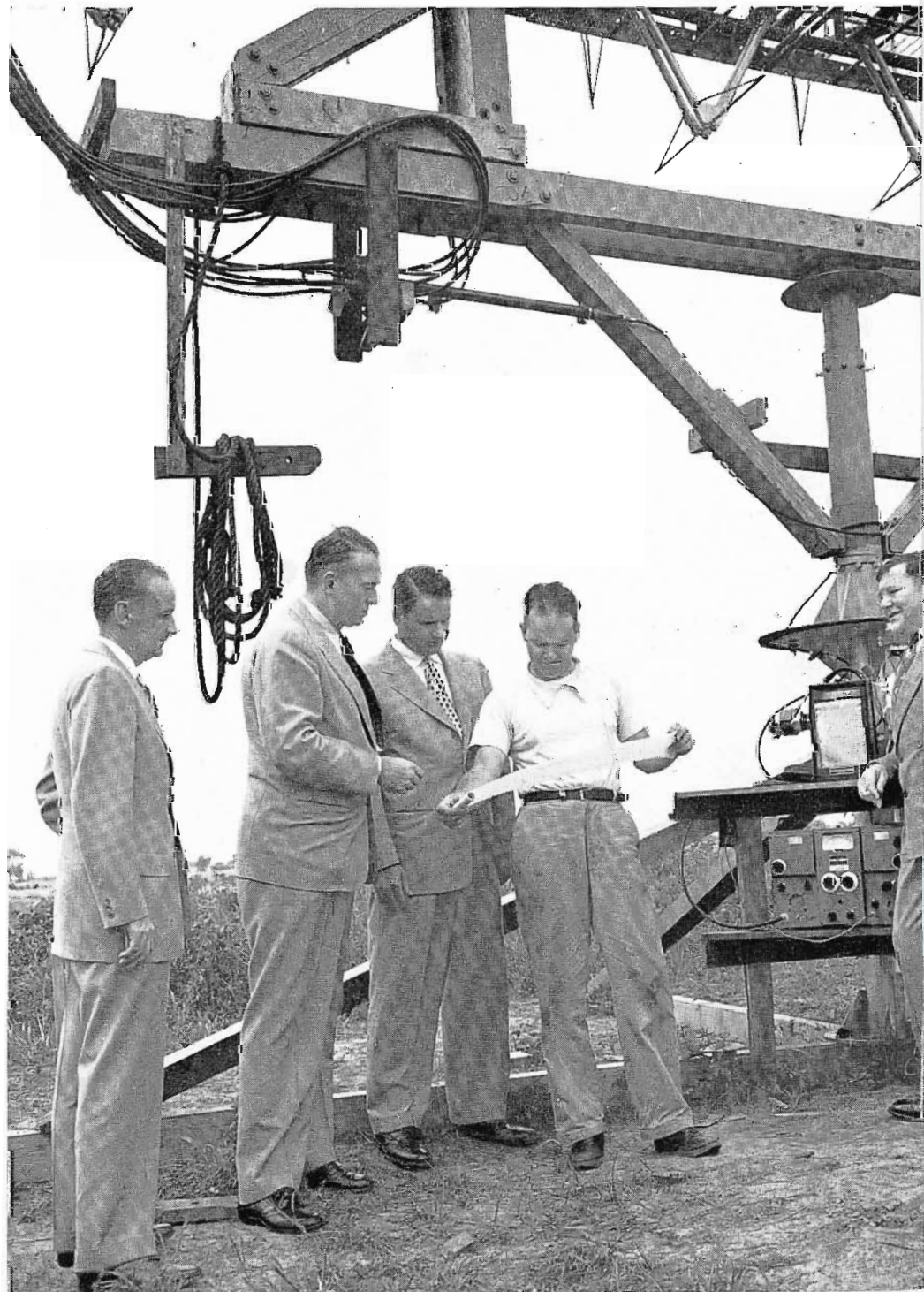

RIGHT: Closeup of the antenna measuring position. In making tests the antenna is used as a receiving antenna to pick up a signal from a fixed transmitter located a short distance away. Received signal is measured by field intensity meter at lower right and recorded on the Esterline-Angus Recorder as the antenna is rotated. Vertical radiation pattern is determined by this method. To determine horizontal pattern the antenna structure is mounted vertically and rotated about the vertical axis. Shown here discussing the operation are (left to right): Tom Howard, Chief Engineer of WPIX, one of the participating stations; Dr. F. G. Kear, of Kear and Kennedy, Consulting Engineers; C. W. Lyon, Jr., Executive Vice President of Empire State; R. S. Grimm, RCA Engineer; and E. S. Clammer, Manager of RCA Antenna Equipment Sales.

NEW WALL TYPE HOUSING FOR LC-1A, "OLSON" SPEAKER

Now available to broadcasters for studio and station monitoring application is a new and practical Speaker Housing (MI-11406) for wall or ceiling installations. Designed specifically for housing the LC-1A, duo-cone speaker mechanism, the

new cabinet is suitable for use in control rooms, auditioning booths, hallways, and executive offices.

The size and shape of the speaker housing (at end view, a 30, 60, 90° modified triangle) is particularly desirable for con-

trol room installations. It may be easily mounted (see sketch below) to provide either a long or short "throw," as desired.

The housing is constructed of heavy plywood, provides good acoustical properties, and is designed for high-quality performance without any sacrifice of duo-cone speaker fidelity.

For best response, the housing is usually flush mounted, so that both wall and ceiling form a part of the acoustical system. Thus, reinforcement from the ceiling may be utilized to raise the bass output and response at the low frequency end. A port is provided for increasing bass response and may be closed or opened, as required.

The overall speaker housing is approximately $17\frac{1}{8} \times 21\frac{3}{4} \times 37\frac{1}{2}$ inches with a sloping front which provides good sound radiation characteristics. The speaker mechanism and wiring are accessible through a removable front panel which permits installation or servicing, without removing the cabinet from the wall.

The housing is finished in umber gray and has an attractive woven plastic grille. Its appearance matches the tone and styling of other studio equipment.

NEW HOUSING, TYPE LC-5A (MI-11406)

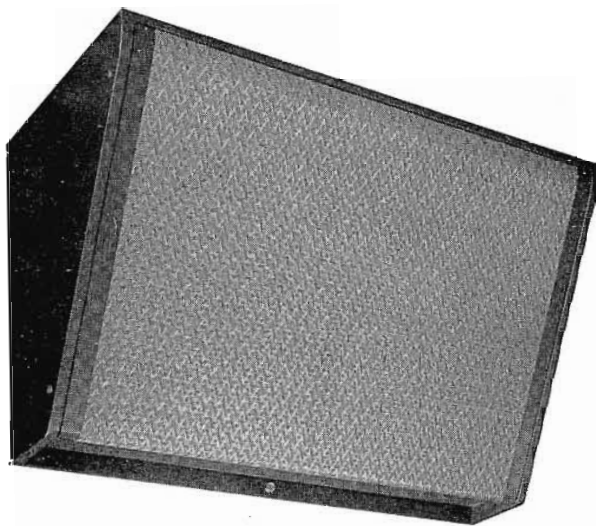

FIG. 1. Designed to accommodate the "Olson" duo-cone speaker mechanism, the new LC-5A housing is ideal for Broadcast Control Rooms and harmonizes with companion equipment.

LC-5A HOUSING WITH DUO-CONE SPEAKER

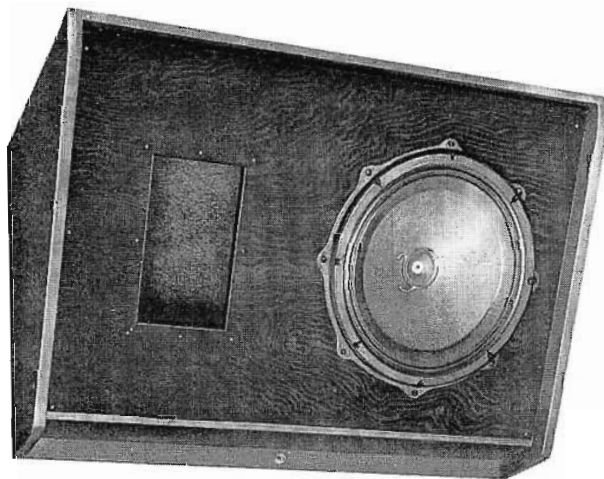

FIG. 2. Front view of housing with grille cover removed to show speaker mounting and bass port.

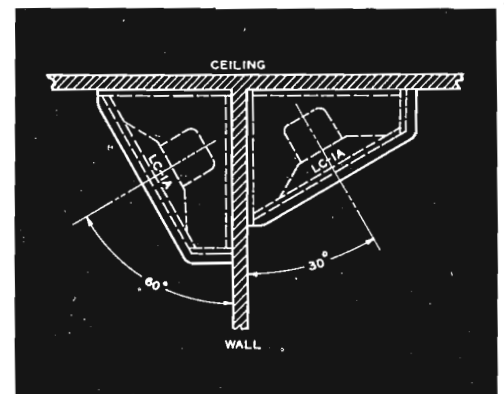

FIG. 3 (above). As shown here, speakers and housings may be mounted at a 30 or 60 degree angle to obtain either a long or short "throw".

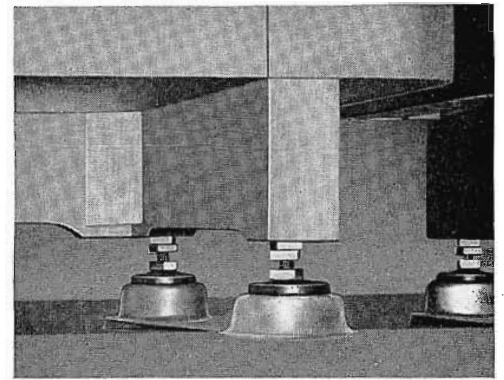
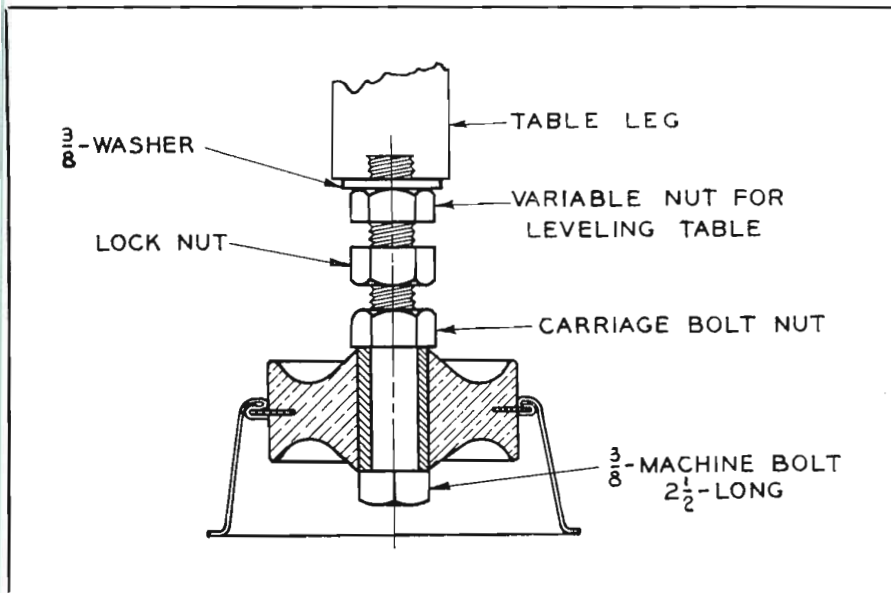

FIG. 1 (above). Partial closeup of 70-C2 turntable legs showing how "Lord" shock mounts are employed.

FIG. 2 (at left). Sectional or "split" drawing of the "Lord" 200PH-45 used to shock mount RCA turntables which are equipped for playing micro-groove records.

HOW TO SHOCK MOUNT "70" SERIES TURNTABLES

by **HAROLD F. STURM**
Chief Engineer, WHTN
Huntington, W. Va.

The use of fine groove records creates new problems with respect to the vibration or jarring of turntables while the records are being played. It is apparent that finer grooves and lighter pressures make shock mounting more difficult than it was in the "old days" when several ounces of pressure was applied to the stylus.

At WHTN, we have employed a rather simple yet effective and satisfactory method of shock mounting RCA 70-C2 series turntables, in order to use the newer, lightweight microgroove arms. Our only "operating" problem has been that of remembering to keep our "arms off" the turntable when playing microgroove records. There has been no resonant rumble or other associated noise experienced with the type shock mounting described. We hope the information given here will prove beneficial to other broadcasters in search of a suitable shock mounting. While this mounting may not work in some cases, it proved the best of three mounts tried for our particular installation.

In the figure above, a split or cross-sectional view is shown of one of the four mounts installed. We used a $\frac{3}{8}$ inch machine bolt ($2\frac{1}{2}$ inches long) to go

through the mount—and a $\frac{3}{8}$ inch carriage nut to hold it tight. Then, two other carriage nuts were used, one to vary the height of the table or level it—and the other to lock the leveling nut. This avoids the possibility of slippage due to vibration, etc. We drilled a hole in the table leg a little larger than the bolt and used a $\frac{3}{8}$ washer. However, it may be desirable to cut some square pieces of metal the width of the table leg to provide more resting surface for the table. We used carriage bolt nuts since they are not as thick as machine nuts. This allows the use of a

shorter bolt which does not raise the table to as great a height from the floor.

The mount described is a Lord mount (200 PH—45) and may be obtained many places as well as from Lord Manufacturing Company, Erie, Pennsylvania. For those who have RCA 70-D Turntables, a $\frac{5}{16}$ —18 bolt ($2\frac{1}{2}$ inches long) is needed. This will fit the threads already present in the base of the turntable. The bolt should either have the head cut off, or should be made long enough to move up and down in the shock mount.



FIG. 3 (at right). View of the WHTN Control Room where the RCA 70-C2 turntables are installed.

COMPOSITION OF THE VIDEO WAVEFORM AS SEEN ON THE SCOPE

By **ROBERT M. CROTINGER**
 Remote Engineering Supervisor
 Station WHIO-TV

The most common oscilloscope pattern seen in television is that of the standard RMA video signal in its entirety when viewed at sweep frequencies of 7,875 and 30 cycles. An analysis of why these patterns look different from the standard textbook representation brings many things to light.

* * *

When first seeing the waveforms of the standard RMA video signal swept out on an oscilloscope at the "horizontal" viewing frequency of 7,875 cycles and the vertical viewing frequency of 30 cycles, the technician usually remarks how different they are from what he expected.

In Fig. 1 is shown an oscilloscope pattern as it would be seen when viewing the standard RMA video signal at the sweep frequency of 7,875 cycles (sawtooth). This is generally referred to as the "horizontal" pattern, since during any one sweep of the scope beam, two horizontal lines will have taken place and thus be traced out on the screen. A linear sweep is used on the scope since the scanning of the television picture takes place linearly with respect to time.

The trace shown in Fig. 1 is seen to consist of the horizontal blanking pulses, "a", also referred to as the pedestal; the horizontal sync pulses, "b"; the video line structures, "c"; a blanking level line, "d"; and a group of interrupted lines, "e".

The first question which arises about the trace shown is why the video, "c", appears as "grass" instead of the standard wavy line shown in textbook drawings of a horizontal line. Then we realize that each line of a normal picture would differ in its shape because of differing light intensities in the makeup of the picture. In the trace shown, light intensities for the video components would increase vertically upward from line "f", which would be black. During the scanning of the video signal by the scope, all the lines of the picture were covered in 1/30th of a second. We recall that motion pictures move because of the persistence of our vision, which is too long to single out any one frame of the number of frames shown in one second. Therefore, because of the persistence of our vision (and of the oscilloscope screen), we see all the lines of the picture traced out on top of each other. Consequently, the trace of video appears as "grass".

The two video traces we see are not the even and odd lines as is sometimes as-

sumed. They cannot be with the continuous scope sweep because as the beam sweeps the first time across the screen, the first two odd lines of the picture will be traced out. Since the camera will be tracing only odd numbered lines during this time and for a number of lines to follow (until one field has been scanned) both odd and even numbered lines will be seen in the "grass" of each of the traces shown.

The blanking level is represented by the peak of the blanking pedestal, "a", which is different from the actual black level "f" by at least five percent of "a". The line "f" does not appear on the trace but is shown to indicate the five percent difference, which difference is intended to allow turning the kinescope brightness up high enough to see the "blackest black picture element" and still not see the retrace lines. The "reference white" line is also not seen on the scope trace but is used to indicate the "whitest white" transmitted.

It will be noted that the entire pattern shown in Fig. 1 is upside down compared to the usual textbook drawing; that is, the sync pulse increases in a downward direction. This pattern was made in proportionate dimensions from a standard television station monitor screen. The polarity of the pattern seen on any scope will of course

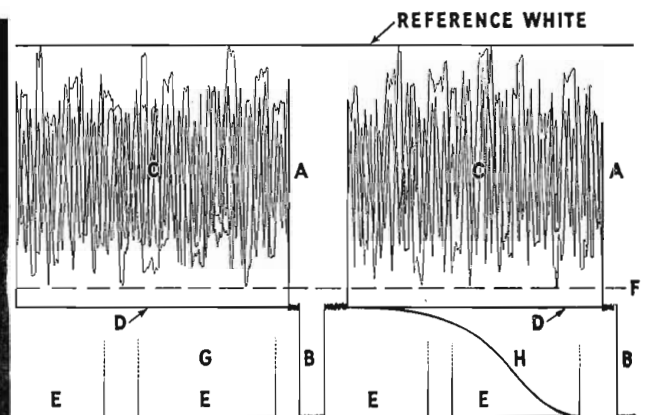
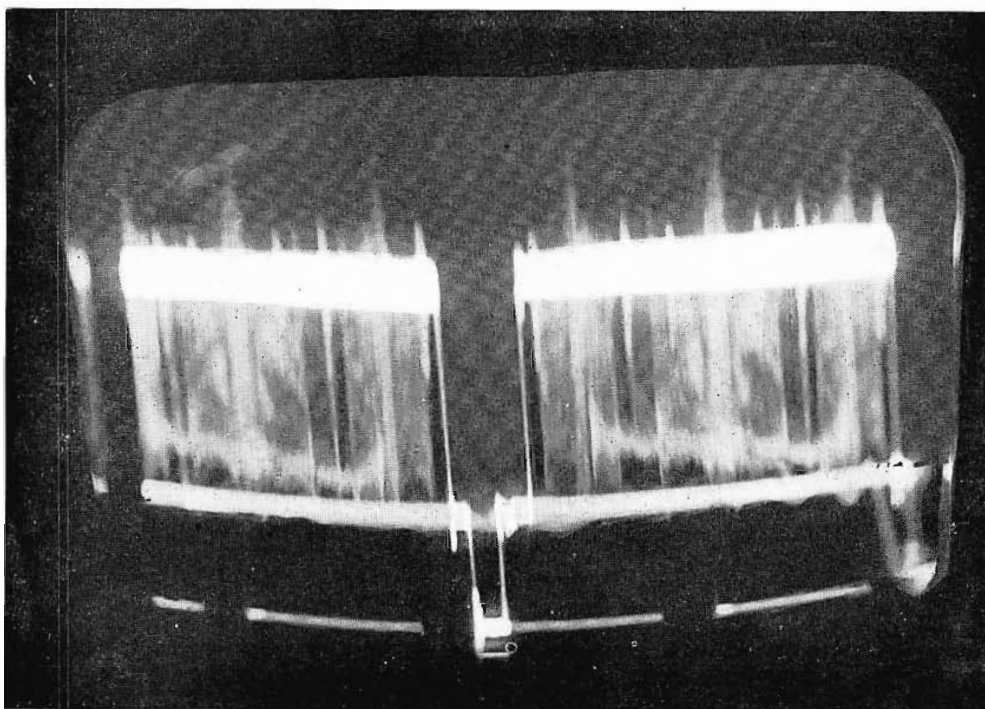

FIG. 1. The photograph from the monitor screen (at left) shows the waveform pattern as it would normally be seen when viewing the standard RMA video signal at the sweep frequency of 7,875 cycles (sawtooth). The diagram above identifies the various parts of the waveform in the photograph at the left. Explanation of the letter symbols is given in the text.

FIG. 3. In order to accurately reproduce these waveforms the oscilloscope used must have a response of at least ten times the horizontal pulse frequency. Either the regular monitor scope (which has a response 300 times the pulse frequency) or an RCA 715-B Oscilloscope, such as that shown here, may be used.

depend on which stage of the system the measurement is made, inverting for each stage of amplification.

The question always arises as to what line "d" is and why it appears where it does. It certainly is not shown in the conventional text drawing of a line of video signal. To explain this it will be recalled that the oscilloscope is still sweeping the screen during the time the camera beam is returning from the bottom of the picture to the top. This return takes several horizontal lines duration to accomplish, and during this time the vertical blanking pedestal is applied to the video signal to blank the receiver beam. Since the beam in our oscilloscope is not blanked out and the sweep oscillator is still functioning during this time, it will trace out a horizontal line at position "d", which is the vertical blanking pedestal level.

Having explained this line, we have also explained the interrupted lines "e". These are obviously the vertical sync pulses placed on top of the vertical blanking pedestal.

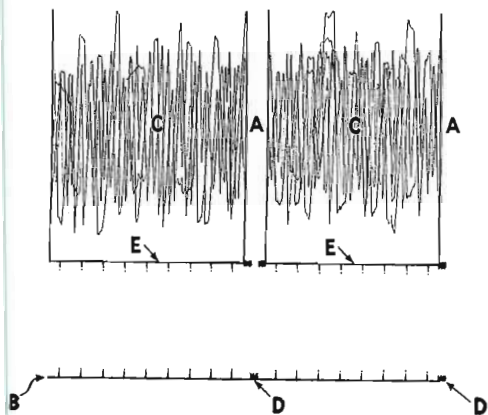
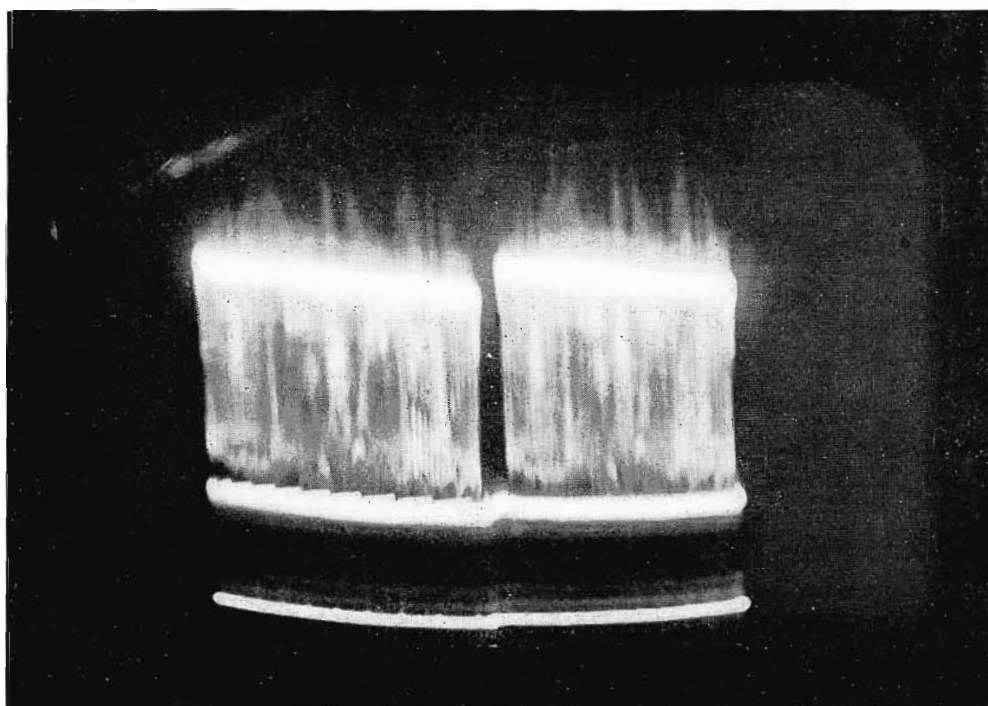
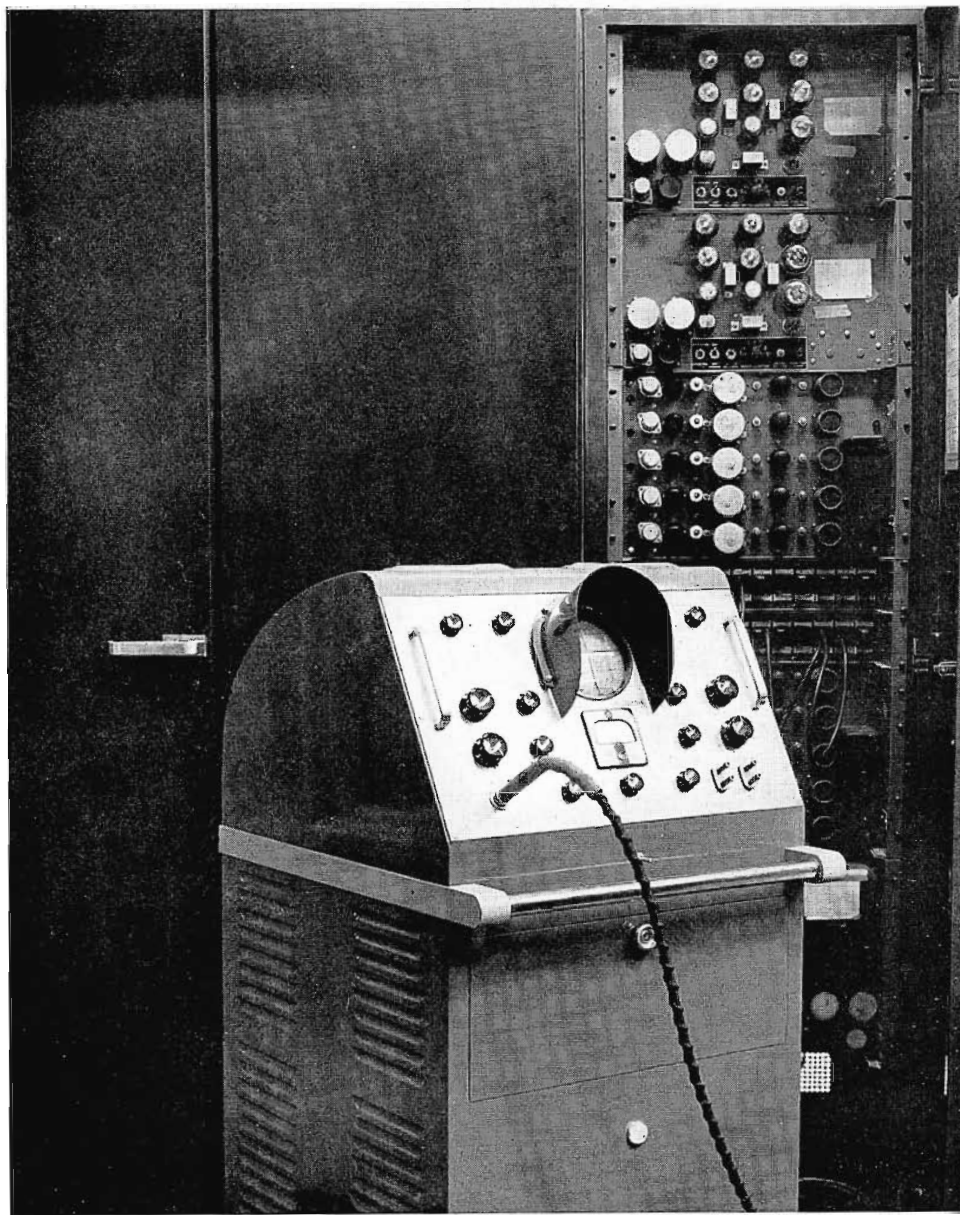

FIG. 2. The photograph from the monitor screen (at the right) shows the waveform pattern as it would normally be seen when the sweep frequency is half the frame frequency (i.e., 30 cycles). The diagram above identifies the various parts of the waveform in the photograph at the right. Explanation of the letter symbols is given in the text.



estal. It is recalled that the vertical sync pulse is serrated. Also their duration is longer than the horizontal sync pulse. Another look at the pattern shows these pulses plainly.

It is also recalled that the front or attack side of the vertical pulse which occurs at the time when a horizontal pulse would otherwise occur, must be at the same time as the horizontal pulse if it were continued. This is done to keep the horizontal oscillators of the receivers in synchronism during the vertical retrace period. Thus the left (attack) end of the horizontal sync pulse "b" in Fig. 1, is also the attack side of vertical sync pulse "g". The top of pulse "b" is brighter than the rest of the lines of the pattern. This is partly because of the application of both the front of the vertical sync pulse "g" and the pulse "b" at this point on the screen, but is mostly because the horizontal pulses are repeated or traced many more times than the vertical serrated pulses.

The final point to remember about this trace is that whatever part of the signal is missing between the right side of the trace and the left side of the trace is that part of the signal which happened during the retrace time of the scope. In the case of this pattern, it was the back side of the second horizontal sync pulse and the back porch of the blanking pedestal. This appears "stretched out" on the retrace as line "h".

It will be noted that the much faster retrace time of the scope has made the rear side of the pulse slope much more than it does when shown on the forward trace. This substantiates the fact that the sides of the pulses are not perfectly perpendicular. If they were, no vertical sides of the pulses would be seen, only the peak horizontal line. It requires a scope having a response of at least ten times the horizontal pulse frequency to accurately reproduce these pulses. Station monitors have a bandwidth of around 300 times the pulse

frequency and thus reproduce the horizontal pulses very accurately.

In Fig. 2 we see the trace made on a scope when the sweep frequency is half the frame frequency, or 30 cycles. Here we do see the even numbered lines of the picture in one video trace and the odd numbered lines in the other. However, we do not know which is which. In any event, it would be of no particular value if we did. Since the scope beam scan takes place in 1/30th of a second, the lines of the first field will be traced out in the first half or 1/60th of a second. The vertical blanking pedestal appears at "a" and the serrated vertical sync pulse at "d". The serrated pulses making up the vertical sync pulse are not definable as such since their time duration is so small compared to the sweep of the scope.

However, several small pulses will be seen to make up the line "b". Since it is apparent that the retrace of the scope includes the video components which are missing between the right and left sides of the trace, in this case the back porch and a few of the lines of the first video trace are *spread out* along the retrace. The much faster retrace motion of the scope beam has elongated the portion of the signal which occurred during the retrace time.

Good practical use can be made of the above in observing the vertical serrated pulses and their components. The fine frequency control of the scope sweep oscillator can be moved very slightly and the second vertical sync pulse "d" made to roll off on the retrace. It will then be elongated and the number of vertical pulses can be actually counted. There should be six equalizing pulses preceding (to the right of) the actual vertical sync pulse, then six longer vertical sync pulses, and finally six more short equalizing pulses to the left of the vertical pulses.

The line "e" is made up of the horizontal blanking pulses for each of the lines of that field. Of course line "b" is made up of the horizontal synchronizing pulses for the lines traced out above it. Since there are $262\frac{1}{2}$ lines, blanking and sync pulses for each of the traces shown, these pulses appear on the screen as a horizontal line.



Field Engineering Service to Broadcasters...AM, FM, TV

RCA Service Company engineers are experienced in all the latest techniques and are equipped with the most modern specialized measuring equipment. The RCA Service Company has been working hand in hand with the nation's broadcasters for over 25 years.

OUR SERVICE TO BROADCASTERS...

- Installation supervision and measurements of transmitting, studio and accessory equipment . . . AM, FM or TV.
- Prompt help in emergencies. Technical advice, service, and assistance on special problems.
- Instruction and training of station operating personnel.
- Performance measurements and adjustments for station compliance with FCC regulations.
- Measurement and curves on FM and TV antennas and accessory equipment, including transmission lines, matching networks, diplexers.

For further information call or write Communications Service Section, RCA Service Company, Inc., Camden, N. J.

NOW—restore the original quality of your RCA microphones, transcription pick-ups and test and measuring equipment under the new Factory-Reconditioning Plan. For complete details, write: Return Apparatus Control, Building 8-2, Camden, N. J.



RCA Service Company, Inc.
A Subsidiary of the Radio Corporation of America
CAMDEN, NEW JERSEY



The new RCA 45 RPM Conversion Kit, MI-11883—installed. The kit is complete with (a) clutch assembly (speed changer); (b) brake-arm assembly; (c) switch and cam shaft assembly; (d) microswitch; (e) dial plate; (f) shaft coupling; and (g) adapter hub.

The fine-groove tone arm and pick-up for "45 RPM" are available extra.

Play 45 RPM's on 70-series Turntables— with RCA Kit MI-11883

NOW you can handle 45's, 78's or 33-1/3's—fine-groove or standard—
—with this kit, and a second tone arm (available extra).

Easy to install

You install the single-unit, ball-type speed reducer between the two flexible couplings in the main drive shaft of your turntable. You transfer the motor switch leads to the micro-switch—included with the kit. That's all there is.

Easy to operate

A motor-control knob on the deck of the turntable controls the speed. Position No. 1 stops the motor. No. 2 shifts the speed control to the 78-33 1/2

rpm speed-change lever (on turntable deck). No. 3 shifts to "45 rpm" position (speed lever set at 78 rpm). *You can shift speeds instantly in either direction while turntable is running.*

Same RCA broadcast dependability

Sturdy construction and accurate mechanical alignment assures you the same quiet, trouble-free service for which more than five thousand RCA turntables are famous.



**AUDIO BROADCAST EQUIPMENT
RADIO CORPORATION of AMERICA**
ENGINEERING PRODUCTS DEPARTMENT, CAMDEN, N. J.

In Canada: RCA VICTOR Company Limited, Montreal

Order your kit (s) today

**RCA ENGINEERING PRODUCTS
DEPT. 19 LC, CAMDEN, N. J.**

- Send me _____ 45 RPM Conversion Kit (s) MI-11883 at once. Price each, \$70.00*.
- Send me _____ fine-groove tone arm and pick-up (s), MI-11884. Price each, \$65.00*.
- Remittance enclosed Ship C.O.D.

NAME _____

ADDRESS _____

CITY _____ STATE _____

STATION _____ *Price applies only in continental U. S. A.

America's Key Network

TV Equipment

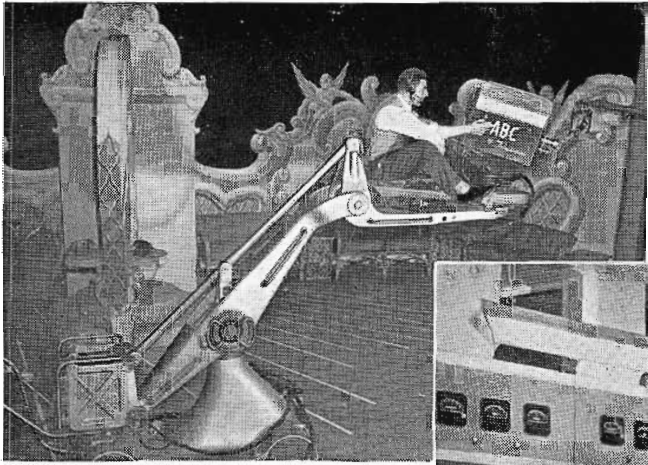

WJZ-TV uses this RCA De Luxe studio crane to get dramatic, viewing angles, smooth panning of big scenes, approaches, retreats.

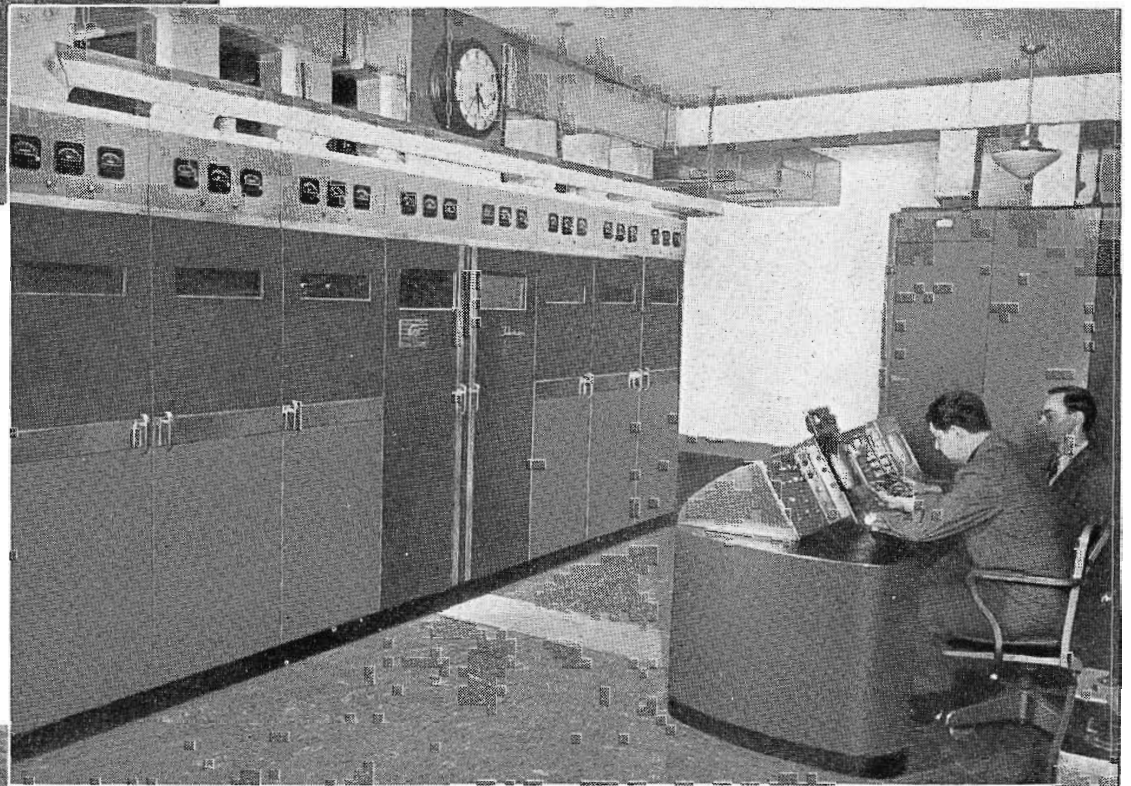

WJZ-TV's Empire State transmitter room is completely RCA-equipped. It includes a 5-kw transmitter (plus 2.5 kw for FM sound), a 500-watt stand-by transmitter, control console, antenna diplexer, vestigial side-band filter, dummy load.

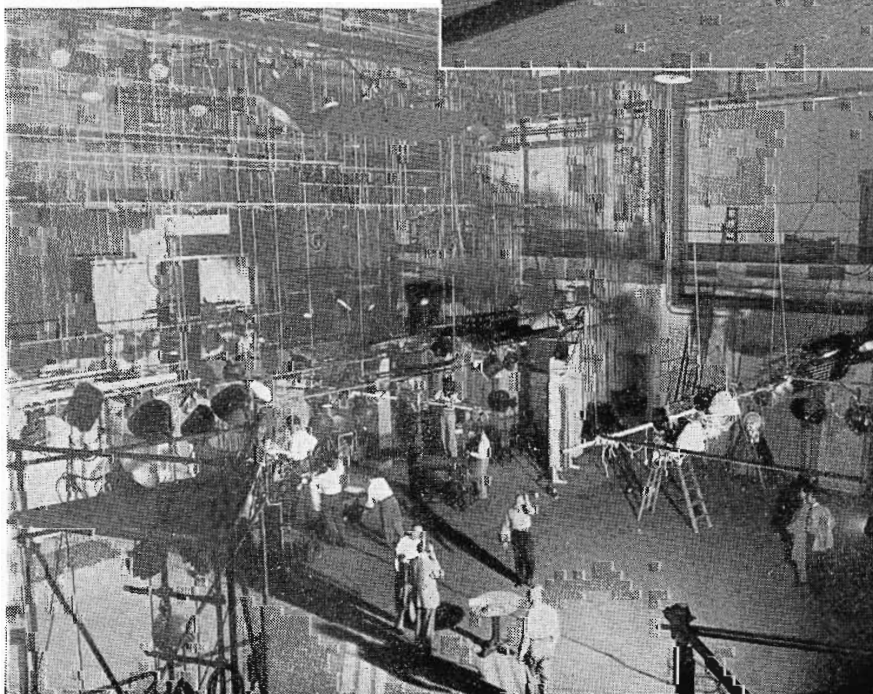

WJZ-TV's famous ABC Studio One—and its six other TV studios—is RCA-equipped with cameras, dollies, booms, stands, mounts, microphones, and accessories.



WJZ-TV uses two fully-equipped RCA field trucks—including seven field cameras.

Stations Use RCA

...WJZ-TV, for instance

Now ON THE AIR from atop the world's tallest television tower... the Empire State building in New York City... WJZ-TV is setting an enviable record for wider coverage, and brighter, clearer pictures over the vast Metropolitan area.

We are proud that the superior service of this important ABC network station is backed by equipment designed and built by RCA. Seven modern studios, complete

with RCA's new remote video relay switching system. A modern film-projection and film-recording room—complete with four Kinefoto film recorders. A fleet of field trucks—with all necessary gear. A complete transmitter room with all associated equipment.

Good reason why WJZ-TV can count on continued unexcelled performance from its new Empire State location.



TELEVISION BROADCAST EQUIPMENT
RADIO CORPORATION of AMERICA
ENGINEERING PRODUCTS DEPARTMENT, CAMDEN, N.J.

In Canada: RCA VICTOR Company Limited, Montreal

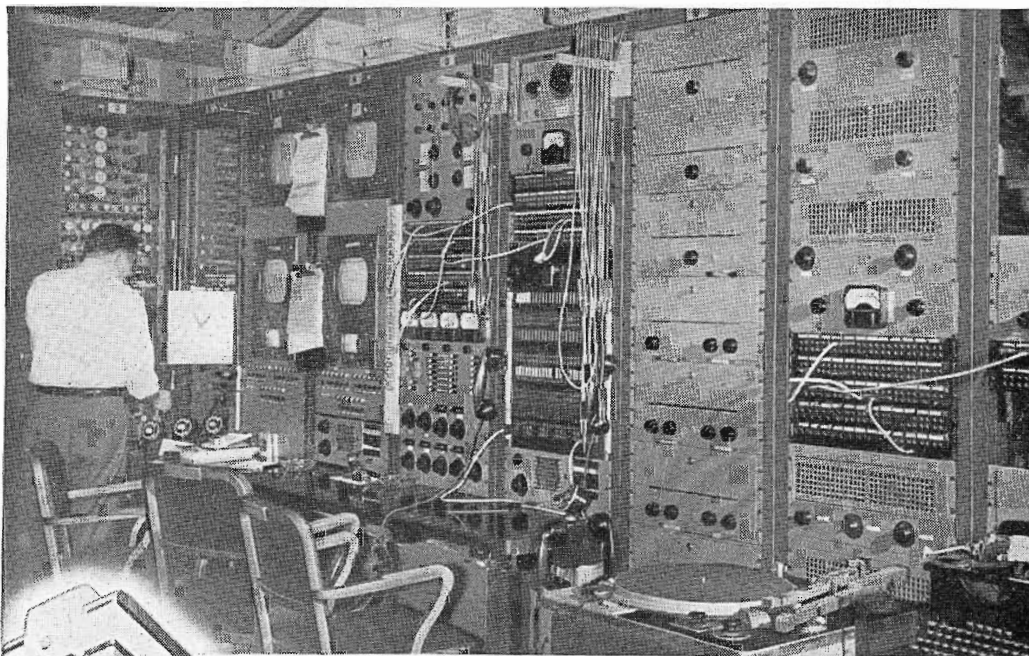

Master Control Room. All seven control rooms of WJZ-TV use RCA equipment—video consoles, program console, audio consoles, microphones, turntables.



WJZ-TV uses RCA Studio Cameras



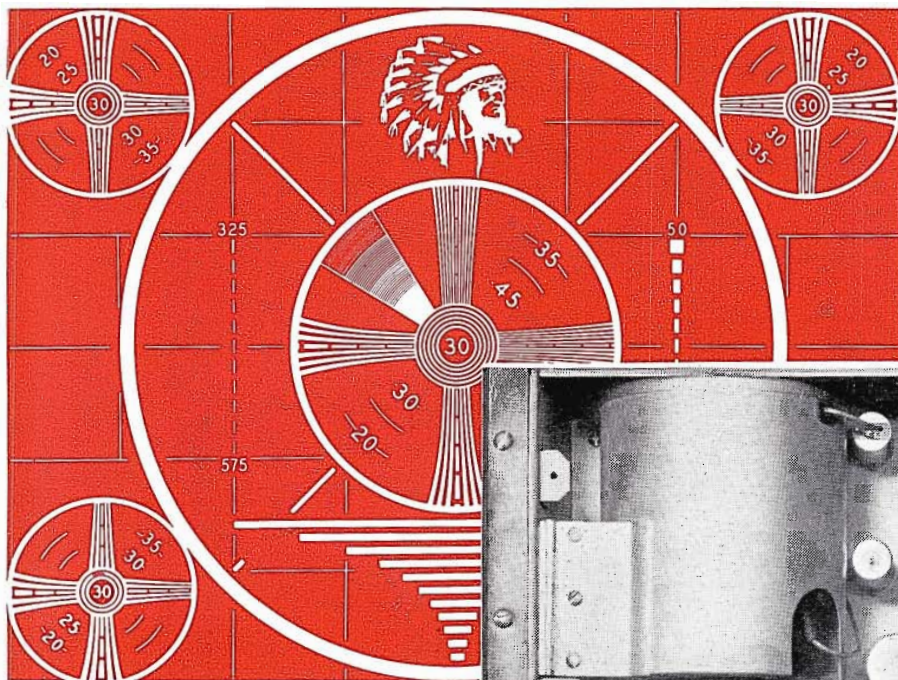

**Video
Monoscope
Camera
TK-1A**

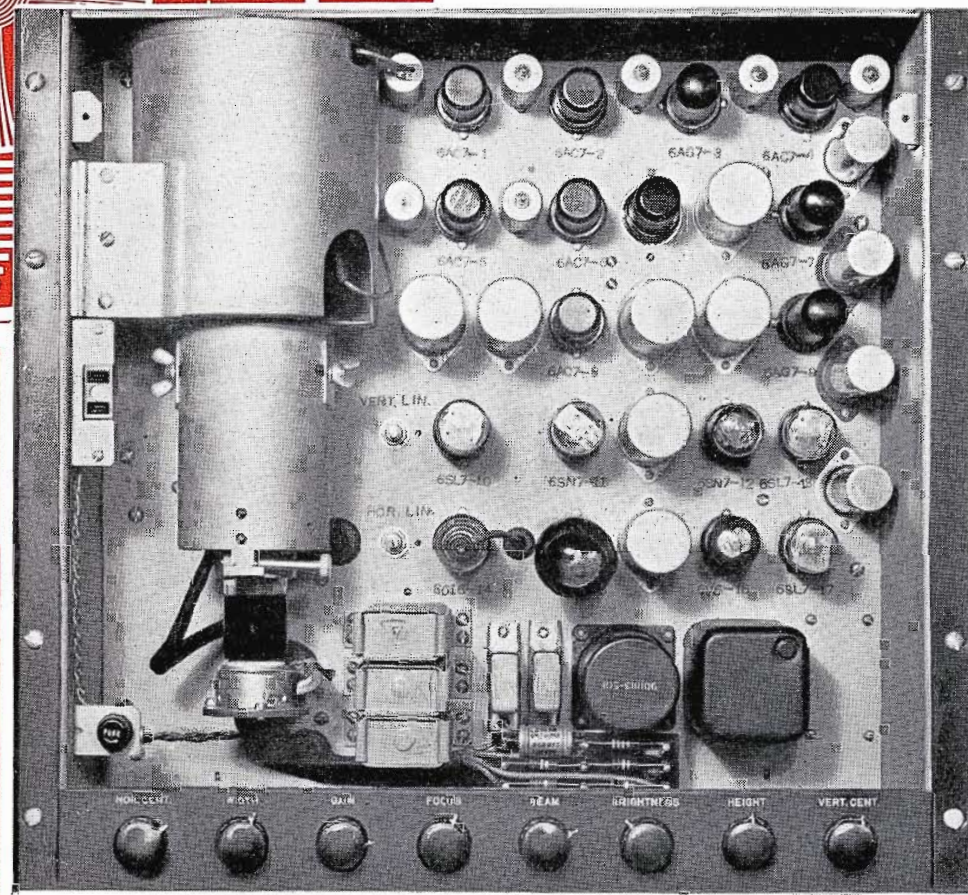

... "patternmaker" for the industry

The test pattern produced by RCA Monoscope Cameras is the standard by which picture quality has been judged since the beginning of electronic television . . . in TV stations . . . in laboratories . . . in TV receiver production.

These are the standard test-pattern cameras used by many TV receiver manufacturers. These are the standard "picture micrometers" used by TV stations to make precision measurements of video transmissions.

Deliberately designed to excel in all things, RCA Monoscope Cameras have earned the extraordinary re-

spect of television men. Evenly lighted patterns as steady as Gibraltar. Resolution as fixed as the cut of a diamond. Operation as reliable as a ship's chronometer.

Type TK-1A pictured here is RCA's newest Monoscope Camera—built to the highest standards known. It can be delivered to you with the familiar monoscope pattern (shown above)—or with a pattern of your own choice.

Ask your RCA Television Equipment Sales Engineer for prices. Mail the coupon for data.



TELEVISION BROADCAST EQUIPMENT
RADIO CORPORATION of AMERICA
ENGINEERING PRODUCTS DEPARTMENT, CAMDEN, N. J.

In Canada: RCA VICTOR Company Limited, Montreal

Radio Corporation of America
Television Broadcast Equipment Section
Dept. 87G, Camden, N. J.

Send me your technical bulletin on the RCA Type TK-1A Monoscope Camera.

Name _____

Company or station _____

Address _____

City _____ State _____



NEW CONVERSION KITS

- MI-11882 for fine-groove cutting.
- MI-11860 and MI-11861 for 45 RPM operation.

The standard high-fidelity recorder for TV and Broadcast Stations, Professional Studios, and Advertising Agencies.

For economical recordings nothing beats a high-fidelity **73-B**

IN PRICE . . . lowest in RCA history* . . . the 73-B compares with any recorder of similar quality!

IN CUTTING COSTS per hour (where the records are permanently retained), the 73-B saves up to 92 per cent—compared with all other recording mediums!

IN RECORD STORAGE space, the 73-B saves up to 83 per cent—compared with all other recording mediums!

33⅓ RPM, and MI-11861 for 45 and 78 RPM.)

Easy to operate, this professional recorder offers technical and economical advantages matched by no other recorder in its class. For details ask your RCA Broadcast Sales Engineer. Or write Dept. 7 G, RCA Engineering Products, Camden, N. J.

*Ask your RCA Broadcast Sales Engineer for the special package price!

New Fine-Groove and 45 RPM Kits

Kit MI-11882 makes it easy to convert your 73-B recorder to cut fine-groove recordings—and reduce your recording costs one half!

New motor drive pulleys make it practicable to operate your 73-B at 45 RPM—and utilize this speed, plus either 33⅓ or 78 RPM. (MI-11860 for 45 and

Look at these low operating costs!

Specifications	Records		
	Normal Groove	Fine-Groove	
		16"	12"
Record Cost per Hour (Records only)	\$4.00	\$2.00	\$2.20
Cu. in. storage space needed per hour of recorded material	36	18	20



AUDIO BROADCAST EQUIPMENT
RADIO CORPORATION of AMERICA
 ENGINEERING PRODUCTS DEPARTMENT, CAMDEN, N. J.

In Canada: RCA VICTOR Company Limited, Montreal

RCA Type WX-2C
540-1600 kc.



THE NEW *Portable Field-Intensity Meter*, RCA Type WX-2C shown one-third actual size. A loop antenna is built right into the lid!

a truly portable **Field-Intensity Meter**

• Weighing only 12½ pounds—including batteries, here's a small, compact field-intensity meter of high accuracy that carries around like a portable radio . . . and operates almost as simply. You tune in a signal, adjust a *built-in* calibrating oscillator and receiver gain . . . and *read signal intensity directly in microvolts-per-meter*. No charts, curves, or correction factors to worry about. No computations to make.

Designed with a wide sensitivity range of 10 microvolts/meter to 10 volts/meter, Type WX-2C enables you to make field-strength readings anywhere—from the very shadow of your transmitter, to the toughest location "down-in-the-

noise." Plenty of front-end selectivity, too. Loop antenna Q is approximately 100 at one megacycle; An r-f amplifier stage provides a very high order of image rejection.

Power supply; Ordinary flashlight dry cells for the quick-heating tube filaments—and a 67-volt battery of the size used in camera-type radios for the B supply.

A lot easier now to get the facts on your coverage, service area, and antenna efficiency . . . with RCA's new portable WX-2C. Ask your RCA Broadcast Sales Engineer for the facts. Or write Department 19-HB, RCA Engineering Products, Camden, New Jersey.



TELEVISION BROADCAST EQUIPMENT
RADIO CORPORATION of AMERICA
ENGINEERING PRODUCTS DEPARTMENT, CAMDEN, N.J.

In Canada: RCA VICTOR Company Limited, Montreal

New BROADCAST CATALOG

Twice as big as 1948-49

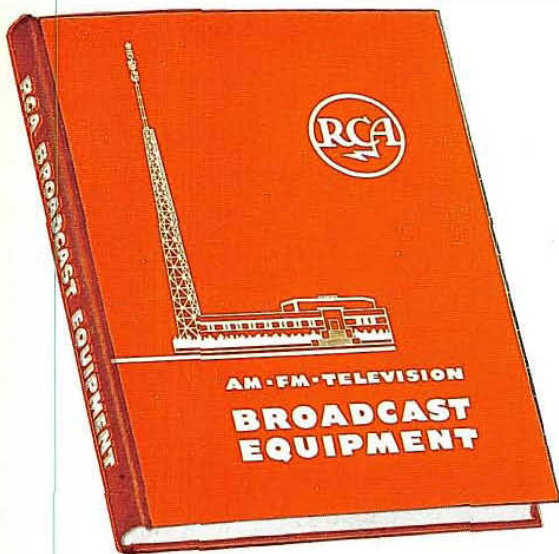

The most complete data book in broadcasting

- Over 400 concise pages of up-to-the-minute specifications and application data.
- 1,068 clear illustrations, easy-to-read curves, and valuable diagrams.
- 1,060 different equipment items covering every broadcast service—audio, AM, FM and TV.

Just off the press—the most complete and authoritative equipment reference ever published for station men.

Containing more than 400 large-size pages of descriptive material, application data, and performance specifications *in a single volume*, the RCA 1950 Broadcast Equipment Catalog covers the entire line of RCA Broadcast Equipment—from Audio, AM, FM and TV equipment to test units.

Each item is described clearly and concisely. Each description includes easy-to-find features, equipment uses, and complete specifications. There are over 40 equipment groupings in all—indexed for quick reference.

If you work with broadcast equipment, here is the book you can put to work the minute you get it.

EQUIPMENT DESCRIBED

Audio Equipment, AM-FM-TV

Microphones
Custom-Built Equipment
Consolettes & Switching
Audio Amplifiers
Remote Equipment
Racks & Rack Equipment
Power Supplies
Turntables
Recorders
Loudspeakers

Video Equipment

Field Equipment
Relay Equipment
Mobile Unit
Studio Cameras
Film Equipment
Studio Control Equipment
Monoscope
Sync Generator
Amplifiers
Power Supplies
Studio Lighting
TV Accessories

Transmitters, AM-FM-TV

AM Transmitters

AM Phasing
FM Transmitters
AM, FM Tubes
TV Transmitters
TV Tubes
Crystals

Antennas, AM-FM-TV

FM Antennas
TV Antennas
Transmission Line Equipment
AM Antenna Tuners
Antenna Towers & Equipment

Test & Measuring Equipment

Measuring Equipment
Monitoring Equipment
Service Test Equipment

Other RCA Products

Sound Equipment
16mm Projectors
Theatre Equipment
Mobile Communications
Equipment



**BROADCAST EQUIPMENT
RADIO CORPORATION of AMERICA
ENGINEERING PRODUCTS DEPARTMENT, CAMDEN, N. J.**

In Canada: RCA VICTOR Company Limited, Montreal

STATION OWNERS, MANAGERS, CHIEF ENGINEERS!

If you have not yet received your complimentary copy, write us on station letterhead.

For additional copies, mail a coupon with your check or money order for \$2.00.

Dept. 19-A, RCA Engineering Products
Camden, N. J.
Send me ___ new RCA 1950 Broadcast Equipment Catalog(s). I enclose \$_____ (check or money order).
Name _____
Title _____
Address _____
City _____ State _____

Dept. 19-A, RCA Engineering Products
Camden, N. J.
Send me ___ new RCA 1950 Broadcast Equipment Catalog(s). I enclose \$_____ (check or money order).
Name _____
Title _____
Address _____
City _____ State _____



Announcing-
the RCA-5826

THE FOUNTAINHEAD OF MODERN TUBE DEVELOPMENT IS RCA

...a major advance in studio-type image orthicons

A NOTABLE PRODUCT of RCA leadership in tube research and engineering—the new RCA-5826 image orthicon offers important refinements over previous types of television camera tubes for studio use.

The new RCA-5826 combines exceptionally high sensitivity, a resolution capability of better than 500 lines, high signal-to-noise ratio—about twice that of outdoor camera types—and improved gray-scale rendition in the vicinity of the “blacks.”

Having the same spectral response as the companion outdoor pickup type RCA-5820—a response closely approaching that of the eye—this new studio camera tube permits portrayal of colors in nearly their true tonal gradation. The use of the 5826 in the studio and the 5820 outdoors facilitates the combination of indoor and outdoor pickups on the same program.

RCA television tube achievements are the very foundation of modern television. And you can depend upon RCA's continued leadership to bring you the finest and most advanced tubes that money can buy.

Whatever the application, there's an RCA television tube to meet your needs. The complete line is available through your local RCA tube distributor, or direct from RCA.

For further information on any RCA tube, see your RCA Distributor or write Commercial Engineering, RCA, Section D36P, Harrison, New Jersey.

The world's most modern tube plant . . .

RCA, LANCASTER, PA.



RADIO CORPORATION of AMERICA

ELECTRON TUBES

HARRISON, N. J.